

Declaration of Conformity

Hereby, Sharp Telecommunications of Europe Ltd, declares that this GX15 is in compliance with the essential requirements and other relevant provisions of Directive 1999/5/EC.

A copy of the original declaration of conformity can be found at the following Internet address:

<http://www.sharp-mobile.com>

Introduction

Congratulations and thank you for choosing the GX15.

About This User Guide

This user guide is carefully designed to help you learn about your phone's features and operations quickly and effectively.

NOTICE

- We strongly recommend that you keep separate permanent written records of all important data. Data may be lost or altered in virtually any electronic memory product under certain circumstances. Therefore, we assume no responsibility for data lost or otherwise rendered unusable, whether as a result of improper use, repairs, defects, battery replacement, use after the specified battery life has expired or any other cause.
- We assume no responsibility, directly or indirectly, for financial losses or claims from third parties resulting from the use of this product and any of its functions, such as stolen credit card numbers, the loss or alteration of stored data, etc.
- All company and/or product names are trademarks and/or registered trademarks of their respective holders.
- Screen layout illustrated in this user guide may differ from the actual one.
The information described in this user guide is subject to change without notice.

- All the functions described in this user guide may not be supported in all networks.
- We assume no responsibility for downloaded contents, information, etc. from network.
- Occasionally, a few black or bright pixels may appear on the screen. Please note that this will not have any impact on any of the features or performance.

Copyright

According to copyright laws, the reproduction, alteration and use of material which is protected by copyright (music, pictures, etc.) is only permitted for personal or private use. If the user is not in possession of more extensive copyright or has not received the explicit permission from the copyright owner to reproduce, alter or use a copy which has been made or modified in this way, this is considered to be a violation of the copyright laws and gives the copyright owner the right to claim for damages. For this reason, avoid the illegal use of material which is protected by copyright.

Windows is a registered trademark of Microsoft Corporation in the United States and/or other countries.

Powered by JBlend™ Copyright 1997-2004 Aplix Corporation. All rights reserved. JBlend and all JBlend-based trademarks and logos are trademarks or registered trademarks of Aplix Corporation in Japan and other countries.



Powered by Mascot Capsule®/Micro3D Edition™
Mascot Capsule® is a registered trademark of HI Corporation
©2002-2004 HI Corporation. All Rights Reserved.

Licensed by Inter Digital Technology Corporation under one or more of the following United States Patents and/or their domestic or foreign counterparts and other patents pending, including U.S. Patents: 4,675,863; 4,779,262; 4,785,450 & 4,811,420.

Licensed under U.S. Patent 4,558,302 and foreign counterparts.

T9 Text Input is licensed under one or more of the following: U.S. Pat. Nos. 5,818,437, 5,953,541, 5,187,480, 5,945,928, and 6,011,554; Australian Pat. No. 727539; Canadian Pat. No. 1,331,057; United Kingdom Pat. No. 2238414B; Hong Kong Standard Pat. No. HK0940329; Republic of Singapore Pat. No. 51383; Euro. Pat. No. 0 842 463 (96927260.8) DE/DK, FI, FR, IT, NL,PT,ES,SE,GB; Republic of Korea Pat. Nos. KR201211B1 and KR226206B1; and additional patents are pending worldwide.

Bluetooth is a trademark of the Bluetooth SIG, Inc.



The Bluetooth word mark and logos are owned by the Bluetooth SIG, Inc. and any use of such marks by Sharp is under license. Other trademarks and trade names are those of their respective owners.

CP8 PATENT

This product is licensed under the MPEG-4 Visual Patent Portfolio License for the personal and non-commercial use of a consumer to (i) encode video in compliance with the MPEG-4 Video Standard ("MPEG-4 Video") and/or (ii) decode MPEG-4 Video that was encoded by a consumer engaged in a personal and non-commercial activity and/or was obtained from a licensed video provider. No license is granted or implied for any other use. Additional information may be obtained from MPEG LA. See <http://www.mpegla.com>.

This product is licensed under the MPEG-4 Systems Patent Portfolio License for encoding in compliance with the MPEG-4 Systems Standard, except that an additional license and payment of royalties are necessary for encoding in connection with (i) data stored or replicated in physical media which is paid for on a title by title basis and/or (ii) data which is paid for on a title by title basis and is transmitted to an end user for permanent storage and/or use. Such additional license may be obtained from MPEG LA, LLC. See <http://www.mpegla.com> for additional details.

Useful Functions and Services

Your phone offers you the following features:

- A built-in digital camera for taking pictures and video clips.
 - A message function for reading and creating SMS messages.
 - MMS (Multimedia Messaging Services) for personalising your phone in various ways.
 - A WAP browser for accessing information on the mobile Internet.
 - Java™ applications. You can also download various applications from Vodafone via the mobile Internet.
 - A melody editing function for creating original ringtones using up to 32 voices.
 - A voice recorder function for recording and playing back voice clips.
 - A *Bluetooth*® wireless technology interface for establishing contact and transmitting data with certain devices. You can transmit pictures, sounds, and video clips to OBEX-enabled phones.
 - An infrared interface for data communication. You can transmit pictures, sounds, and video clips to OBEX-enabled phones.
- A data synchronization function for synchronizing the Contacts List and schedule entries with Microsoft Outlook or Outlook Express on a PC.
 - A schedule alarm for creating and sending schedule entries with alarm settings.

Table of Contents

Introduction	1	Using the Menu	27
Useful Functions and Services	3	List of Menu Functions	28
Your Phone	7	Contacts List	29
Optional Accessories	7	Selecting the Storage Memory	29
Getting Started	8	Changing the List Displayed	29
Inserting the SIM Card and the Battery	10	Changing the Name Order	30
Charging the Battery	12	Add New Contact	30
Turning Your Phone On and Off	13	Copying Contacts List Entries between	
Keypad Lock	14	SIM Card and Handset	31
Display Indicators	15	Finding a Name and Number	31
Navigating Functions	17	Dialling from the Contacts List	32
Call Functions	18	Editing Contacts List Entries	32
Making a Call	18	Deleting Contacts List Entries	32
Speed Dialling	18	Viewing Groups	32
Redialling	19	Group Call	33
Answering a Call	19	Assigning a Ringtone to Each Contacts	
Incall Menu	20	List Entry	33
Entering Characters	24	Memory Status	34
Changing the Input Languages	25	Speed Dial List	34
Changing the Input Method	25	Sending a Contacts List Entry	34
Using Text Templates	26	Receiving a Contacts List Entry	35

Dialling a Service Phone Number	35	Java™ Information	70
Camera	36	Applications	71
Take Picture	36	SIM Application	71
Record Video	40	Alarms	71
Messages	44	Calculator	72
Multimedia (MMS)	44	Voice Recorder	73
Text (SMS)	49	Melody Editor	74
Cell Broadcasts	52	Phone Help	78
Vodafone live!	54	Calendar	79
Starting the WAP Browser	54	Contacts	82
Navigating a WAP Page	55	Call Log	82
My Items	58	Speed Dial List	83
Pictures	58	My Numbers	83
Games & More	60	Call Timers	83
Sounds	61	Data Counter	83
Videos	63	Call Costs	84
Text Templates	65	Settings	85
Memory Status	66	Connectivity	85
Games & More	67	Profiles	88
Applications	67	Setting the Display	93
Screensavers	68	Sound	96
More Games	68	Call Settings	96
Settings	69	Date & Time	100

Changing the Language	101
Network	101
Security	104
Master Reset	105
Connecting GX15 to Your PC	106
System Requirements	106
GSM/GPRS Modem	106
Handset Manager	107
Software Installation	107
Note	107
Troubleshooting	109
Safety Precautions and Conditions of Use	111
CONDITIONS OF USE	111
ENVIRONMENT	114
PRECAUTIONS CONCERNING VEHICLE USE	114
SAR	115
PRECAUTIONS FOR USE IN USA	115
Index	118

Your Phone

Please check the following carefully. Your phone should come complete with:

- GSM 900/1800/1900 GPRS phone
- Rechargeable Li-ion battery
- AC charger
- CD-ROM
- User guide
- Quick start guide

Optional Accessories

- Li-ion Spare battery (XN-1BT30)
- Cigarette lighter charger (XN-1CL30)
- USB data cable (XN-1DC30)
- AC charger (XN-1QC30, XN-1QC31)
- Personal handsfree kit (XN-1ER20)

The above accessories may not be available in all regions.

For details, please contact your dealer.

Getting Started

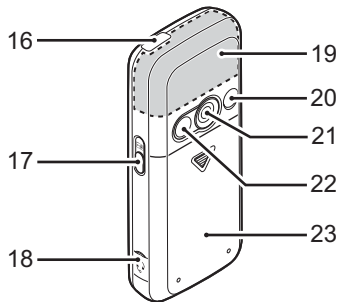
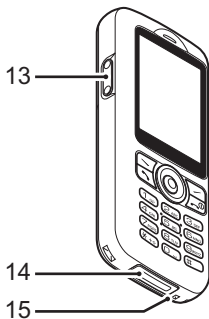
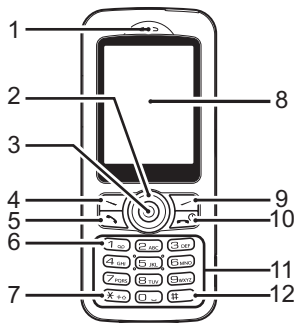

1. Earpiece

2. Navigation Keys (Arrow Keys):



Moves cursor to select menu items, etc.

Up/Down arrow keys: Displays Contacts List entries in stand-by mode.

Left arrow key: Displays list of Applications in stand-by mode.

Right arrow key: Displays list of Saved Pictures in stand-by mode.

3. Centre Key:



Displays Main menu in stand-by mode and executes functions.

4. Left Soft Key:











Executes the function at the bottom left of the screen.

5. Send Key:



Makes or accepts calls, views the call in stand-by mode.

- 6. Voice Mail Key:**
 Press and hold this key to connect to the Voice mail centre automatically.
(Depends on the SIM card.)
- 7. * /Shift Key:**
 Switches character case among four modes: Abc, ABC, 123 and abc.
- 8. Display**
- 9. Right Soft Key:**
 Executes the function at the bottom right of the screen. Used to access “Vodafone live!” by opening the browser in stand-by mode.
- 10. End/Power Key:**
 Ends a call, turns power on/off.
- 11. Keypad**
- 12. # Key:**
 Switches symbol screens. Press and hold this key on the text entry screen to shift text input method between multi-tap and T9 mode. Press and hold this key during stand-by to switch Profiles settings between Normal and Silent mode. Press , then  during stand-by to activate Voice Recorder.
- 13. Side-Up/Side-Down Keys:**
 Moves cursor to select menu items, adjusts earpiece volume, etc.
- 14. External Connector:**
Used to connect either the charger or USB data cable.
- 15. Microphone**
- 16. Infrared Port:**
Sends and receives data via infrared.
- 17. Camera Key:**
Starts the digital camera in stand-by mode. Takes pictures or records videos in viewfinder mode.
- 18. Handsfree Kit Connector**
- 19. Built-in Aerial:**
Warning: Do not cover the top of the phone with your hand when in use as this may interfere with the performance of the built-in aerial.
- 20. RF Connector**
- 21. Camera**
- 22. Self-Portrait Mirror:** For taking a self-portrait.
- 23. Battery Cover**

Inserting the SIM Card and the Battery

1. Slide off the battery cover (① ②).

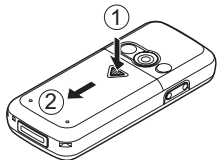

2. Slide the SIM card into the SIM holder.

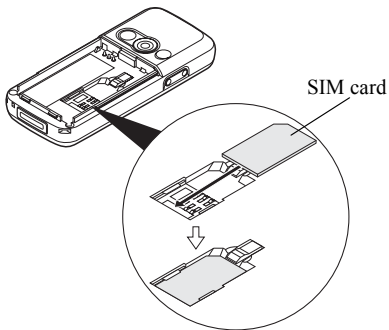

3. Hold the battery so that the metal contacts of the battery are facing down, slide the guides on the top of the battery into the battery slots ①, and then insert it ②.

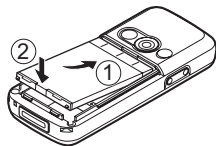

4. Replace the battery cover and slide it as shown below.

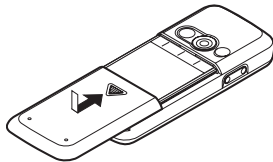

Note

- Make sure that only 3V SIM cards are used.
- Make sure that the standard accessory battery (XN-1BT30) is used.

Removing the SIM Card and the Battery

1. Make sure to turn off your phone and disconnect the charger and other accessories. Slide off the battery cover (① ②).

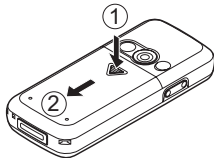

2. Pick up the battery using the protruding edge and remove the battery from the phone.

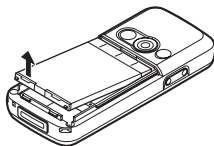

3. Hold down gently ① whilst sliding the SIM card out of the SIM holder ②.

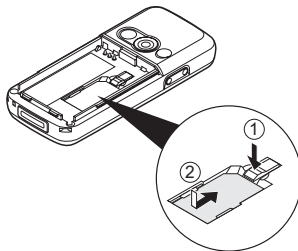

Battery Disposal

The device is supported by a battery. In order to protect the environment, please read the following points concerning battery disposal:

- Take the used battery to your local waste depot, dealer or customer service centre for recycling.
- Do not expose the used battery to an open flame, into water or dispose with the household waste.

Charging the Battery

You must charge the battery for at least 2 hours before using your phone for the first time.

Using the Charger

1. Remove the cover of the external connector, and connect the charger to the external socket located at the bottom of the phone by pressing both sides indicated with arrows. Connect the charger to an AC outlet. Keep the cover in a safe place so as not to lose it.

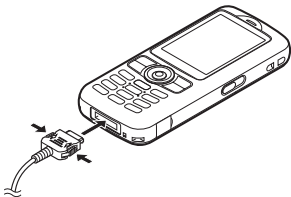

When the phone is charging, the animated battery status icon () in the upper right of the screen displays the current status.

Standard charging time: Approx. 2 hours.

Note

- *Charging time may vary depending on the state of the battery and other conditions. (See “Battery” on page 112.)*

To Disconnect the Charger

Push and hold the side buttons of the charger, then disconnect the charger from the external socket of the phone.

2. When charging is complete, the battery indicator icon displays the full charge status. Unplug the charger from the AC outlet, then unplug the charger connector from the phone. Put the cover back.

Note

- *Do not use any non approved charger, this may damage your phone and invalidate any warranty, please see “Battery” on page 112 for details.*

To Charge Using the Cigarette Lighter Charger

The optional cigarette lighter charger supplies power for charging from the cigarette lighter socket of a car.





Battery Level Indicator

The current battery level is displayed in the upper right hand side of the screen.

Low Battery During Use

When the battery is running low, an alarm will sound and the “” is displayed on the screen.

If you are using your phone and you hear the “low battery” alarm, attach your charger as soon as possible. The phone may not be able to continue normal operation if you continue to use it. The battery may only last approximately five minutes before the phone itself powers down during a call.

Battery Indicators	Charge Level
	Sufficiently charged
	Partially charged
	Charging recommended
	Charging required
	Empty

Turning Your Phone On and Off

To turn the power on, press and hold  for approximately 2 seconds.

The stand-by screen is displayed.

To turn the power off, press and hold  for approximately 2 seconds.

To Enter the PIN Code

If activated you are asked to enter a PIN (Personal Identification Number) code after turning on your phone.

1. Enter your PIN code.
2. Press .

Note

- If your PIN code is entered incorrectly three times in a row, the SIM card is locked. See “Enabling/Disabling the PIN Code” on page 104.

To Copy Contacts List from the SIM Card

When you insert the SIM card into your phone for the first time and start the Contacts List application, you are asked whether you wish to copy Contacts List entries on the SIM card. Follow the on-screen instructions, or you can do it later using the Contacts List menu as follows:

“Contacts” → **“Contacts List”** → **[Options]** → **“Advanced”** → **“Copy All Entries”**

1. Select “From SIM to Handset”.

Keypad Lock

You can lock the keypad to prevent it from being pressed accidentally.

Locking the Keypad

1. Press **[*+0]**, then [LockKeys] during stand-by.
The soft and centre keys are not displayed.
To unlock, press **[*+0]**, then [Yes].







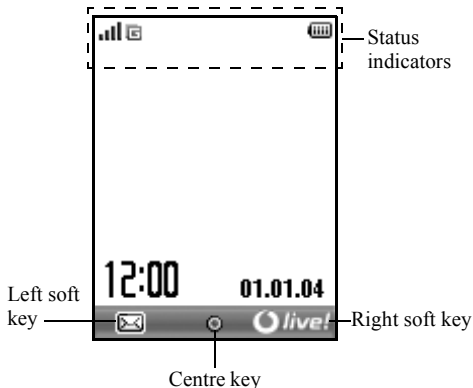













Tip























- *Emergency numbers (112, etc.) can be input and dialled regardless of the keypad lock.*
- *To lock the keypad automatically, see “Auto Keypad Lock” on page 104.*

Display Indicators



Status Indicators

1.  / : Strength of received signal / Service out of range
2. : GPRS enabled and within range — flashes during GPRS transmission.
3.  /  / : Alerts [Text message / Multimedia message / WAP]
4.  / : Java™ application [executed (colour) / suspended (grey)]
5. (No display) /  /  /  /  /  / : Current profile [Normal / Meeting / Activity / Car / Headset / Silent]
6. : T9 text input method enabled
7.  /  /  / : Current text input method [First letter upper case / Upper case / Lower case / Numeric]
8. : “Diverts” (p. 96) set to “All Calls”

- 9. / : Secured WAP page displayed
- 10. : Call incoming
- 11. : Call in progress
- 12. / : Current WAP or MMS communication mode [CSD / GPRS]
- 13. : Battery level
- 14. : Roaming outside network
- 15. : “Ringer Volume” (p. 88) set to “Silent”
- 16. : Vibration alert (p. 89) enabled
- 17. : USB data cable connected
- 18. / : “Infrared” connection [enabled (grey) / communicating (red)]
- 19. / : *Bluetooth* wireless setting [enabled / communicating]
- 20. : Data communication mode enabled
- 21. : Fax communication mode enabled
- 22. : Outbox contains unsent multimedia messages
- 23. : Voicemail message alert
- 24. : Daily alarm enabled
- 25. / : Schedule entry enabled [with / without reminder alarm]
- 26. : Keypad Lock (p. 14, p. 104) enabled

Navigating Functions

All applications are accessed from the Main menu. To open the Main menu, press the centre key (○) during stand-by.

To launch applications, you will need to highlight menu items, and make selections. To select a menu item (indicated in quotation marks), move the cursor using ▲, ▼, ◀ and ▶, and press ○ to commit your selection.

In certain procedures, you will need to press one of the soft keys (indicated in square brackets), which are displayed at the bottom left and right of the screen. Press the corresponding soft key (☐ or ☐).

To return to the previous screen, press the right soft key if it displays “Back”. To close the Main menu, press the right soft key if it displays “Exit”.

Each section in this user guide starts with a list of items you will need to select in order (indicated in italics) before performing the procedures shown. Select each item to reveal the next set of items that you have to select. Open subsection items after opening those listed in the main section.

Example:

“Contacts” → *“Contacts List”* → [*Options*] → *“Advanced”*

Call Functions

Making a Call

1. Enter the area code and the phone number you wish to dial and press  to dial.

If you enter the wrong number, press [Clear] to delete the number to the left of the cursor.



Emergency Calls

1. Enter 112 or 911 (international emergency number) using the keypad and press  to dial.



Note

- *Emergency calls may not be available on all mobile phone networks when certain network services and/or phone features are in use. Contact your network operator for more information.*
- *This Emergency number can normally be used to make an emergency call in any country, with or without a SIM card inserted, if a GSM network is within range.*



International Calls

1. Press and hold  until a “+” (international dialling prefix) sign is displayed.
2. Enter the country code, followed by the area code (without the leading zero) and the phone number, and press  to dial.

Speed Dialling





Up to 9 phone numbers from the Contacts List memory (Handset and SIM) can be assigned to speed dials. You can call the numbers using the digit keys ( to  and ).

For details on setting the Speed Dial List, see “Speed Dial List” on page 34.

1. To dial a number using the speed dial, press and hold any of the digit keys ( to  and ).
The phone number stored in the Speed Dial List is dialled.

Redialling

You can redial numbers in the call log. Select from specific categories or “All Calls”. Specific category contains up to 10 numbers and the “All Calls” list contains up to 30.

1. Press  during stand-by.
2. Select the category from “All Calls”, “Dialled Nos.”, “Missed Calls” or “Received Calls”.
To switch logs, press  or .
3. Select the phone number you wish to call.
4. Press  to redial the call.

Automatic Redialling

This setting allows you to automatically redial the number if the first attempt was unsuccessful because the called party was busy.

If you wish to stop redialling, press  or [End].

To Set the Auto Redial Function

“Settings” → “Call Settings” → “Auto Redial”

1. Select “On” or “Off”.



Note

- When you receive an incoming call, the Auto Redial function is interrupted.

- Automatic redialling is not available for fax and data calls.

Answering a Call

When an incoming call is detected, the phone rings.

1. Press ,  or [Answer] to answer the call.
Or press any key except  and [Busy] when the “Any Key Answer” function is enabled. Set the Any Key Answer function in the profile of each mode. (p. 92)

Tip

- When the Personal handsfree kit (option) is connected to the phone, you can answer calls by pressing the Answer button.
- If you have subscribed to the Calling Line Identification (CLI) service and the caller’s network sends the number, the caller’s number is displayed on the screen. If the caller’s name and number are stored in the Contacts List, the caller’s name and phone number are displayed on the screen.

- *If the number is a restricted number, the display shows “Withheld”.*
- *When receiving a call from the person whose picture is registered in the Contacts List, receiving display and the picture are displayed alternately.*

Rejecting an Incoming Call

1. Press  or press and hold the side-up or side-down key whilst the phone is ringing to reject a call you do not wish to answer.

Letting the Caller Know You are Unavailable



1. Press [Busy] whilst the phone is ringing to send a busy tone to the caller of an incoming call letting them know that you cannot answer the call.

Incall Menu

Your phone has additional functions available whilst a call is in progress.

Adjusting the Earpiece Volume

During a call, you can adjust the earpiece volume (and handsfree volume, if connected).

1. During a call, press the side-up or side-down key to display the Earpiece Volume screen.
2. Press the side-up key (or ) to increase the volume of the call or press the side-down key (or ) to decrease the volume.
Five levels (level 1 to 5) are selectable.
3. Press  when the volume is set to the desired level.

The phone returns to the in-call screen automatically if left unoperated.

Putting a Call on Hold

This function allows you to manage two calls at the same time. If you wish to make another call whilst you are talking to someone, you can put the current call on hold to call someone else.

To Make Another Call during a Call

1. During a call, press [Options].
2. Select “Hold”.
The current call is put on hold.
3. To retrieve a call, press [Options] and select “Retrieve”.
4. Enter the phone number you wish to make another call to, then press .

Tip

- You can also make another call by entering the phone number during a call instead of steps 1 and 2. The current call is automatically put on hold.

Call Waiting

This service notifies you of another incoming call whilst you have a call in progress.

1. During a call, press [Options] and select “Hold & Answer” to answer the second call.
The first call is put on hold and you can now talk to the second caller.
2. Press [Options] and select “Swap Calls” to switch between the two calls.
3. Press [Options] and select “Release Call” to end the current call and return to the held call.

Note

- You need to set “Call Waiting” to “On” if you use the Call Waiting service (p. 97).
- Call Waiting service may not be available on all networks. Contact your network operator for more information.
- If you do not wish to answer the second call, press [Busy], or press [Options], and select “Busy” or “Reject”, in step 1. If “Reject” is selected, the call log of the second call is saved as a missed call.

Accessing SMS Menu During a Call

1. During a call, press [Options] and select “Text”.
The following options are available: “Create Message” to make an SMS, or “Inbox”, “Sent” or “Drafts” to access these folders. For details on SMS, see “Text (SMS)” on page 49.

Conference Call

Conference call is a call with more than 2 participants. You may include up to 5 participants in a conference call.

To Make a Conference Call

To make a conference call, you must have one active call and one held call.

1. During a call, press [Options] and select “Multiparty” to answer the second call.
2. Select “Conference All” to join the conference call.
3. Press  to end the conference call.

Note

- *Conference call service may not be available on all networks. Contact your network operator for more information.*
- *You have more options for the Conference call in step 2:*
 - *To put all participants on hold, select “Conf. Hold All”.*
 - *To put all participants except the current call on hold, select “Private”.*
 - *To end the call with all participants, select “Release All”.*
 - *To disconnect from the conference call but still allow the other participants to continue talking together, select “Transfer”.*
 - *To put the current call on hold and continue to have a conference call with the remaining participants, select “Exclude”.*
 - *To reject adding more participants to the current party, select “Reject”, or you can send the busy tone by selecting “Busy”.*

To Add New Participants to the Conference Call

1. Press [Options] and select “Dial”.
2. Enter the number you wish to include in the conference call and press  to dial.
3. Press [Options] and select “Multiparty”.
4. Select “Conference All” to join the conference call.
If you wish to add other participants, repeat steps 1 to 4.

To End the Call with a Conference Call Participant

1. During a conference call, highlight the person that you wish to disconnect from the conference call.
2. Press [Options] and select “Release Call”.

To Have a Private Conversation with One of the Participants

If you wish to have a private conversation with one of the participants, you may select the participant from the conference list and put the other participants on hold.

1. During a conference call, select the person that you wish to talk to.
2. Press [Options] and select “Multiparty”.
3. Select “Private”.
4. Once you have finished the private conversation, press [Options] and select “Multiparty”.
5. Select “Conference All” to return to the conference call.

Muting the Microphone

1. During a call, press [Mute] to mute the microphone.
To unmute the microphone, press [Unmute].

Entering Characters

When entering characters to create Contacts List entries, text messages or multimedia messages, etc., press the corresponding keys.













In multi-tap input method, press each key until the desired character is displayed. For example, press  once for the letter “A” or twice for the letter “B”.

Table of Characters

Pressing each key scrolls characters in the following order. The order varies depending on the language selected.

English Mode

Key	Upper Case Characters	Lower Case Characters	Numeric
	. (full-stop) , (comma) - (hyphen) ? ! ' (apostrophe) @ : 1		1
	ABC2	abc2	2
	DEF3	def3	3
	GHI4	ghi4	4
	JKL5	jkl5	5
	MNO6	mno6	6

Key	Upper Case Characters	Lower Case Characters	Numeric
	PQRS7	pqrs7	7
	TUV8	tuv8	8
	WXYZ9	wxyz9	9
	(space)+ = < > € £ \$ ¥ % & 0		0
	Switches character case among four modes: Abc, ABC, 123 and abc.		
	. , ? ! : ; - + # * @ ' " () _ & € £ \$ % / ~ < > § = \ ¥ ÿ î ^ [] { } □ Å Ä Æ å ä æ à Ç È é é i Ñ ñ Ò Ø ö ø ò ß Û ü ù Δ Φ Γ Λ Ω Π Ψ Σ Θ Ξ (space) ␣		

 -  : Press and hold to enter 0 - 9 numbers.



 : Press and hold to enter *.

 : Press and hold to shift between multi-tap and T9 mode.

Changing the Input Languages

You can change the input language on the text entry screen.



1. On the text entry screen, press [Options].
2. Select “Input Language”.
If “Input Language” is not displayed, select “Text Options” and then select “Input Language”.
3. Select the desired language.



Changing the Input Method

T9 Text Input

T9 text input method is a shortcut to enter text easily and quickly.

1. On the text entry screen, press and hold  to enter T9 mode.
2. Press [Options].
3. Select “Input Method”.
If “Input Method” is not displayed, select “Text Options” and then select “Input Method”.
4. Select the input mode (Abc, ABC, abc, 123).
5. Press each key once for any letter you require on that key.

To enter the word “How”, press   .

6. If the word shown isn’t the one you want, press  or  until you highlight the correct one.
7. Press  to select the word.

Note

- If the correct word is not shown in step 6, enter the correct word again after switching to the multi-tap input method.

Tip

- If you press  instead of step 7, a space is inserted next to the selected word.

Symbols and Punctuations

1. On the text entry screen, press [Options].
2. Select “Add Symbol”.
If “Add Symbol” is not displayed, select “Text Options” and then select “Add Symbol”.
3. Select the desired symbol.

My Dictionary

You can create your own word list for T9 text input.

1. On the text entry screen in T9 mode, press [Options].
2. Select “My Dictionary”.
If “My Dictionary” is not displayed, select “Text Options” and then select “My Dictionary”.
3. Select “Add New Word” and enter a new word.

To edit a word in the list

1. On the text entry screen in T9 mode, press [Options].
2. Select “My Dictionary”.
If “My Dictionary” is not displayed, select “Text Options” and then select “My Dictionary”.
3. Highlight the desired word.
4. Press [Options] and select “Edit”.
5. Modify the word.

Using Text Templates

You can use the sentences registered in Text Templates when entering characters.



For details on creating the text template, see “Adding Phrases to Text Templates” on page 65.

1. On the text entry screen, move the cursor to the point you wish to insert the template.
2. Press [Options].
3. Select “Text Template”.
If “Text Template” is not displayed, select “Text Options” and then select “Text Template”.
4. Select the desired text template.
The selected text template is inserted.

Using the Menu

Accessing Applications



1. Press  during stand-by.
The Main menu is displayed.
2. Navigate to required location.
3. Press  to access function.

Shortcut Keys

You can shortcut to the specified menus by pressing  and digit keys for the menu's corresponding number on the Main menu. See the following table for reference. Shortcuts are listed in the headings of this manual. For example: "M 9-7".

Example: To Access "Language" Sub Menu
Using Shortcut Keys

Press   .

Note

- The shortcut keys work for the first three menu levels only.

List of Menu Functions

Menu No./ Main Menu	Menu No./ Sub Menu1
1 Games & More	1 Applications 2 Screensavers 3 More Games 4 Settings 5 Java™ Information
2 Vodafone live!	1 Vodafone live! 2 Games 3 Ringtones 4 Pictures 5 News 6 Sport 7 Find & Seek 8 Chat 9 Search
3 Applications	1 SIM Application* 2 Alarms 3 Calculator 4 Voice Recorder 5 Melody Editor 6 Phone Help
4 Messages	1 Create Message 2 Multimedia 3 Text 4 Media Album 5 Vodafone Mail 6 Messenger 7 Cell Broadcasts 8 Area Info

Menu No./ Main Menu	Menu No./ Sub Menu1
5 Camera	1 Take Picture 2 Record Video
6 My Items	1 Pictures 2 Games & More 3 Sounds 4 Videos 5 Text Templates 6 Bookmarks 7 Memory Status
7 Calendar	
8 Contacts	1 Contacts List 2 Add New Contact 3 Call Log 4 Speed Dial List 5 My Numbers 6 Call Timers 7 Data Counter 8 Call Costs 9 Service Dialling No.*
9 Settings	1 Connectivity 2 Profiles 3 Display 4 Sound 5 Call Settings 6 Date & Time 7 Language 8 Network 9 Security 0 Master Reset

* Depends on SIM card contents.

Contacts List (M 8-1)

You can store the phone numbers and e-mail addresses of your friends, family and colleagues in the Contacts List.

Depending on the size of the entry, your phone can store up to 640 phone numbers. In a Contacts List, you can store the following items.

Items stored in the handset memory

First Name

Last Name

Tel Mobile

Tel Private

Tel Office

E-mail Private

E-mail Business

Group

Address

Note

Tip

- *There is no character limit for entering text into the above fields when using the internal memory.*

Items stored in the SIM memory

Name: The number of characters that can be stored differs depending on the SIM card you use.

Phone number: Up to 40 digits

Using the infrared or *Bluetooth* wireless function, you can send the Contacts List entry to a PC to share the same entries.

Selecting the Storage Memory

“Contacts” → “Contacts List” → [Options] → “Advanced” → “Save New”

1. Select Contacts location from “Handset Memory”, “SIM Memory” or “Choose then Save”.

Tip

- *“Choose then Save” prompts you to choose the memory every time you save a new entry.*

Changing the List Displayed

“Contacts” → “Contacts List” → [Options] → “Advanced” → “Contacts Location”

1. Select from “Handset Memory”, “SIM Memory” or “Both”.

Changing the Name Order

“Contacts” → **“Contacts List”** → [Options] → **“Advanced”** → **“Name Order”**

1. Select from “First - Last name” or “Last - First name”.

Add New Contact (M 8-2)

You can choose either the phone or SIM card memory locations to store the new entry. For switching locations, see “Selecting the Storage Memory” on page 29.

The amount of phone numbers that you can store to the SIM card is dependent on its capacity. Contact your network operator for details.

“Contacts” → **“Add New Contact”**

If you select the “Choose then Save” option for the memory to be used, the selection is between “To Handset” and “To SIM”.

1. Select the field you wish to fill in, and enter the relevant information.
2. Press [Save] when finished.

Tip

- To create an entry, at least one field must be filled. If you create a new entry on the SIM card, you need to enter a phone number.

Adding a Thumbnail to Entries

“Contacts” → **“Contacts List”**

1. Highlight the desired entry.
2. Press [Options] and select “Edit”.
3. Press [Options] and select “Picture”.
4. Select the desired picture.
5. Press [Save] when finished.

Note

- If you delete a picture in Saved Pictures, the corresponding thumbnail is also deleted.
- If the picture size exceeds 120 dots [W] or 160 dots [H], specify the area you wish to display.

Copying Contacts List Entries between SIM Card and Handset

“Contacts” → “Contacts List” → [Options] → “Advanced” → “Copy All Entries”

1. Select “From SIM to Handset” or “From Handset to SIM”.

Note

- When you insert the SIM card into your phone for the first time and start the Contacts List application, the confirmation screen appears automatically, asking you if you wish to copy or not. The number of Contacts List entries to be copied varies depending on the SIM capacity.

Copying a Single Entry from Handset to SIM Card

“Contacts” → “Contacts List”

1. Select the desired entry.
2. Highlight the desired phone number.
3. Press [Options] and select “Copy to SIM”.

Finding a Name and Number

“Contacts” → “Contacts List”

1. Enter the first few letters of the name.
Search results are displayed in alphabetical order.

Tip



- You can select the Contacts location from “Handset Memory”, “SIM Memory” or “Both” before searching.
- To view the details of the item such as address, highlight the desired item, press [Options] and select “View”.

Dialling from the Contacts List

“Contacts” → “Contacts List”

1. Highlight the desired entry and press .

Tip

- If more than one phone number is registered for the entry, select the desired phone number after step 1 and press . You can also dial the desired phone number by pressing the digit key corresponding to the position the entry is on the list.
- You can also dial from the details screen of the Contacts List. On the details screen, select the desired phone number and press .
- If you select “SIM Memory” for the “Contacts Location” option in Contacts List menu (p. 29), only one phone number entry is displayed.

Editing Contacts List Entries

“Contacts” → “Contacts List” → [Options] → “Edit”

1. Select the field you wish to edit, and modify the information.
2. Press [Save] when finished.

Deleting Contacts List Entries

Deleting All Contact Entries

“Contacts” → “Contacts List” → [Options] → “Advanced” → “Delete All Entries”

1. Enter your handset code.
2. Select “Handset Entries” or “SIM Entries”.
The default handset code is “0000”. For details on changing the handset code, see “To Change Handset Code” on page 105.

Deleting a Contact Entry

“Contacts” → “Contacts List”

1. Highlight the desired entry.
2. Press [Options] and select “Delete”.

Viewing Groups

You can set group icons when storing Contacts entries so that you can easily find and edit them.

“Contacts” → “Contacts List” → [Options] → “Advanced” → “Group” → “View Groups”

1. Select the desired group.
“” appears next to the selected group. Select the group again to cancel, and the checkbox becomes unchecked.

Tip

- Press [Options] and select “Current Only” to view only the selected group or “Select All” to view all groups.

Group Call

Different ringtones can be set for each group. When you purchase this phone, groups are set to off. If you do not set a group ringtone, the ringtone assigned in the Settings menu is used.

“Contacts” → **“Contacts List”** → [Options] → **“Advanced”** → **“Group”** → **“Group Call”**

1. Select the desired group.
2. Select “Switch On/Off”.
3. Select “On” or “Off”.
4. Select “Assign Ringtone”.
5. Select “Preset Sounds” or “My Sounds”.
6. Select the desired ringtone.
For details on selecting a ringtone, see “Assigning Ringtone” on page 89.
7. Select “Vibration” and select from “On”, “Off” or “On & Link to Sound”.

For details on selecting a vibration, see “Vibration” on page 89.

8. Press [OK].

Assigning a Ringtone to Each Contacts List Entry

A specified ringtone or vibration setting can be associated to a pre-registered entry.

“Contacts” → **“Contacts List”**

1. Select the desired entry.
2. Press [Options] and select “Edit”.
3. Press [Options] and select “Ringtone”.
4. Select “Switch On/Off”.
5. Select “On” or “Off”.
6. Select “Assign Ringtone”.
7. Select “Preset Sounds” or “My Sounds”.
8. Select the desired ringtone.

For details on selecting a ringtone, see “Assigning Ringtone” on page 89.

9. Select “Vibration” and select from “On”, “Off” or “On & Link to Sound”.

For details on selecting a vibration, “Vibration” on page 89.

10. Press [OK].
11. Press [Save].

Memory Status

This function helps you to check the memory used in the Contacts List.

“Contacts” → “Contacts List” → [Options] → “Advanced” → “Memory Status”

Speed Dial List

You can set a maximum of 9 phone numbers in the Speed Dial List (p. 83).

Setting Contacts List Entries in the Speed Dial List

“Contacts” → “Contacts List”

1. Select the desired entry.
2. Highlight the desired phone number.
3. Press [Options] and select “Add to Speed Dial”.
4. Select the desired list number.

Tip

- The nine digit keys correspond to list numbers.
- To view the speed dial list, see page 83.

Sending a Contacts List Entry

“Contacts” → “Contacts List”

1. Highlight the desired entry.
2. Press [Options] and select “Send Contact”.
3. Select “Via Bluetooth” or “Via Infrared”.

For “Via Bluetooth”

The phone starts searching for *Bluetooth* wireless technology enabled devices within 10 metres.

When detected, a list of enabled devices is displayed allowing you to select the desired device. The connection can be established and the entry sent.

For “Via Infrared”

The phone starts searching for an infrared-enabled device within 20 centimetres.

When detected, the infrared connection is established and the entry is sent.

Note

- *When pairing, you need to enter your passcode when establishing contact with a Bluetooth wireless technology enabled device for the first time.*

Receiving a Contacts List Entry

When the phone receives a Contacts List entry, a confirmation message appears in the stand-by mode screen.

1. Press [Yes].

The received entry is registered in the Contacts List.
Press [No] to reject.

Tip

- *For details on making Infrared or Bluetooth wireless settings, see “Connectivity” on page 85.*

Dialling a Service Phone Number

Certain SIM cards contain service phone numbers that can be dialled. Contact your SIM card vendor for more information. On the Contacts screen, “Service Dialling No.” is displayed at the bottom of the list.

“Contacts”

1. Select “Service Dialling No.”.
2. Select the desired service phone number.

Tip

- *If the SIM card contains only one service phone number, you can dial it in step 1 by pressing .*
- *If no service phone number is stored in the SIM card, this menu is not displayed.*

Camera (M 5)

Your phone has an integrated digital camera.

This allows you to take and send pictures or video clips wherever you are.

Take Picture (M 5-1)

Put the phone into the digital camera mode to take a picture. Pictures are saved in Saved Pictures in JPEG format in the following three picture sizes.

 L: 480 × 640 dots



 M: 240 × 320 dots

 S: 120 × 160 dots

Taking Pictures

“Camera” → “Take Picture”

The preview is displayed through the screen.

1. Press  or the Camera key to take the picture.
The shutter sounds and the still image of the taken picture is displayed. Press [Cancel] to retake a picture.
2. Press [Save].
“Saving (file name) to My Items...” is displayed, then the picture is registered.
3. Press  to return to stand-by.

Remaining shots indicator

123: Indicates the remaining number of pictures that can be taken.

Tip

- Pressing the Camera key during stand-by also activates digital camera mode.
- If you wish to send a picture by multimedia message after taking the picture, press  before step 2. Then select “Multimedia” or “Postcard”. (The Postcard service is not available on some service providers. Please contact your service provider for more information.) Large MMS messages may cause the size of attached pictures to be reduced.

Using the Full Screen

The preview can be displayed on the full screen without the soft key area and indicators.

“Camera” → “Take Picture” → [Options] → “Full Viewfinder”

1. Select “On” or “Off”.



Tip

- You can also turn on or off the full screen mode by pressing .



Taking a Self-Portrait

To take a self-portrait, hold the phone with the mirror facing you whilst holding the phone at least 40 cm away. Press  or the Camera key to take the picture.

Using the Zoom Function

Press  or  to change the zooming ratio.

Zooming ratio indicators

   : Magnification.

Note

- When “Picture Size” is set to “S”, the zoom function has 3 magnifications ($\times 1$, $\times 2$, $\times 4$).
- When “Picture Size” is set to “M”, the zoom function has 2 magnifications ($\times 1$, $\times 2$).

Selecting the Picture Size

“Camera” → “Take Picture” → [Options] → “Picture Size”



1. Select the desired picture size.

Selecting the Picture Quality

“Camera” → “Take Picture” → [Options] → “Picture Quality”

1. Select “Normal” or “Fine”.

Picture quality indicators

 : Fine
 : Normal

Selecting the Anti-flicker Mode

“Camera” → “Take Picture” → [Options] → “Anti-flicker”

1. Select “Mode 1: 50Hz” or “Mode 2: 60Hz”.

Note



- Vertical stripes may occur on the picture due to the light source. Change the anti-flicker mode to rectify.
- The digital camera uses a C-MOS sensor. Although this camera has been manufactured to the highest specifications, some pictures may still appear too bright or too dark.
- If the phone has been left in a hot place for a long time before taking or registering a picture, the picture quality may be poor.

In the Case of No Available Memory





When the number of pictures that can be taken becomes 3 or less, the remaining shots indicator in the upper left of the screen turns red. (The number of pictures that can be taken is approximate.)

When the number of pictures that can be taken becomes 0, and when you try to take a picture again, “Memory full. Please delete some data!” is displayed.

Adjusting the Brightness of the Picture According to Lighting Conditions

Press  or  to adjust the brightness of the picture.

Picture brightness (exposure level) indicators

    : (Bright → Normal → Dark)

Once the phone has returned to the stand-by screen, the brightness settings return to default.

Viewing the Taken Pictures

“Camera” → “Take Picture” → [Options] → “My Pictures”

The list of pictures is displayed.



1. Select the file you wish to view.
The selected picture is displayed.

Tip

- Your pictures are given file names which are “pictureNNN.jpg” (NNN is a consecutive number). The file name (without an extension), date and size of your pictures are displayed in the list.





Using the Timer (Delay Timer)

“Camera” → “Take Picture” → [Options] → “Delay Timer”

1. Select “On” or “Off”.
“” or “” is displayed on the screen and the phone returns to digital camera mode.

2. Press  or the Camera key to start the delay timer. 10 seconds after the timer sounds, the shutter sounds, and the camera takes a picture.

Note

- The countdown sounds whilst the delay timer is operating.
- If  or the Camera key is pressed whilst the delay timer is operating, the picture is taken instantly.
- The zoom function with  or , or brightness adjustment of the picture with  or , is unavailable whilst the delay timer is operating.
- If you wish to stop taking pictures with the timer, press [Cancel] whilst the delay timer is operating.

Continuous Shoot

Four pictures are taken in succession. Auto Shoot and Manual Shoot are available.



Continuous Shoot indicators



When pictures are taken in Continuous Shoot mode, these indicators appear on the screen.

- * When delay timer and Continuous Shoot functions are simultaneously set, “” is displayed instead.

“Camera” → “Take Picture” → [Options] → “Continuous Shoot”

1. Select “Auto Shoot” or “Manual Shoot”.
Select “Off” to cancel.
2. Press  or the Camera key to start Continuous Shoot.
Auto Shoot: Four pictures are taken in a row.
Manual Shoot: Pictures are taken one by one by pressing  or the Camera key.
The taken pictures are saved automatically.
To stop Continuous Shoot, press [Cancel].

Note

- When “Picture Size” is set to “L” or “M”, you cannot use the Continuous Shoot.
- When you select a frame for taking pictures, you cannot use the Continuous Shoot function.
- Delay timer cannot be used with the Manual Shoot.

Selecting a Frame

You can select the frame from preset patterns. You can also select a frame in Saved Pictures.

“Camera” → **“Take Picture”** → [Options] → **“Add Frame”**

1. Select “Preset Frame” or “My Pictures”.
2. Select the desired frame.

The selected frame is confirmed on the display.

3. Press .

Note

- When “Picture Size” is set to “L” or “M”, you cannot use the Frame function.
- When you activate the Continuous Shoot, you cannot use the Frame function.
- Only images in PNG format can be selected as the frame if you select “My Pictures” in step 1. However, images larger than 120 [W] × 160 [H] cannot be used.

Selecting the Shutter Sound

You can select the shutter sound from 3 preset patterns.

“Camera” → **“Take Picture”** → [Options] → **“Shutter Sound”**

1. Select the desired shutter sound.

To play back the shutter sound, press [Play].

Note

- Continuous Shoot uses the specialised shutter sound that cannot be changed for the above settings.

Record Video (M 5-2)

Put the phone into the video camera mode to record a video.

Video clips are saved in “.3gp” format in the following two modes:

Record size indicators



: Message sending mode enabled



: Extended video mode enabled

Recording Video Clips

Sound can be recorded with the video clip.

“Camera” → **“Record Video”**

The preview is displayed through the screen.

1. Press  or the Camera key to start recording the video clip.

The sound for recording the video clip occurs.

If you press  or the Camera key again, or when the recording is completed, the sound for ending the video clip recording occurs and the display transits to step 2.

2. Select “Save”.

“Saving (file name) to My Items...” is displayed, then the video clip is registered.

To preview a video clip before saving, select “Preview”.



To send a video clip by multimedia message after recording the video clip, select “Save and Send”.

To record a video clip again, press [Cancel].

Remaining sets indicator

123 : Indicates the remaining sets of video clips that can be recorded.

Using the Zoom Function

Press  or  to change the zooming ratio.

Zooming ratio indicators

   : Magnification.

Selecting the Recording Size Mode

You can select the recording size mode.

“Camera” → “Record Video” → [Options] → “Record Size”

1. Select “Extended Video” or “For Message”.

Note

- If “For Message” is selected, the size of the video clip that can be recorded depends on the message size set in MMS settings (p. 48).
- When the Message Size described on page 48 is set to “100 KB”, “Record Size” is not displayed.
- “Save and Send” is not displayed after recording in extended video mode.

Selecting Video Quality

“Camera” → “Record Video” → [Options] → “Video Quality”

1. Select “Normal” or “Fine”.

Video quality indicators

 : Fine

 : Normal

Selecting the Anti-flicker Mode

“Camera” → “Record Video” → [Options] → “Anti-flicker”

1. Select “Mode 1: 50Hz” or “Mode 2: 60Hz”.

Note



- Vertical stripes may occur on the preview screen due to the light source. Change the anti-flicker mode to rectify.

In the Case of No Available Memory





When the number of video clips that can be recorded becomes 3 or less, the remaining sets indicator in the upper left of the screen turns red. (The number of sets that can be recorded is approximate.)

When the number of video clips that can be recorded becomes 0, and when you try to record a video clip again, “Memory full. Please delete some data!” is displayed.

Adjusting the Brightness of the Video Clips According to Light Conditions

Press  or  to adjust the brightness of the video clip.

Picture brightness (exposure level) indicators

    : (Bright → Normal → Dark)

Once the phone has returned to the stand-by screen, the brightness settings return to default.

Viewing Recorded Video Clips

“Camera” → “Record Video” → [Options] → “My Videos”

The list of video clips is displayed.

1. Select the file you wish to view.

2. Press .





The selected video clip is played back.

To pause playback, press .

To resume playback, press  again.

To stop playback, press [Back].



Tip

- Your video clips are given file names such as “videoNNN.3gp” (NNN is a consecutive number). The file name (without an extension), date and size of your video clips are displayed in the list.
- If the video clip has been recorded with sound, the volume can be adjusted by pressing  (or , the side-up key) or  (or , the side-down key).
- The volume varies depending on the Multimedia Volume settings (p. 91). The sound is deactivated when “Multimedia Volume” is set to “Silent”.





Using the Timer (Delay Timer)

To Record a Video Clip with the Timer

“Camera” → “Record Video” → [Options] → “Delay Timer”

1. Select “On” or “Off”.
“” is displayed on the screen and the phone returns to video camera mode.
2. Press  or the Camera key to start the delay timer.
10 seconds after the timer sounds, the camera starts recording the video clip.

Note

- *The countdown sounds whilst the delay timer is operating.*
- *If  or the Camera key is pressed whilst the delay timer is operating, the video clip is recorded instantly.*
- *The zoom function with  or , or brightness adjustment of the video with  or , is unavailable whilst the delay timer is operating.*
- *If you wish to stop recording video clips with the timer, press [Cancel] whilst the delay timer is operating.*

Recording Video Clips with Sound

“Camera” → “Record Video” → [Options] → “Voice Record”

1. Select “On” or “Off”.

Messages (M 4)

Your phone allows you to send and receive text or multimedia and to receive WAP alerts.

Multimedia (MMS) (M 4-2)

About Multimedia Messaging

Multimedia Messaging Service (MMS) allows you to send and receive multimedia messages with graphical images, photographs, sound, animations or video clips attached.

Note

- *Some MMS functions may not always be available depending on your network. Contact your network operator for more information.*

Creating a New MMS (M 4-2-1)

✉ → “Multimedia” → “Create Message”

1. Enter the message.

To use the text template, move the cursor to the point you wish to insert the template. Press [Options] and select “Text Options”. Select “Text Template” and then select the desired template.

2. Enter the phone number or e-mail address of the recipient.

3. Select “Send”.

After the message is sent, the message is moved to the Sent box.

Note

- *The current message size displayed whilst you are creating the message is an approximation.*
- *If a message cannot be sent for some reason, the message stays in the Outbox and “✉” is displayed on the stand-by screen.*

Tip

- *You can use the phone number or e-mail address from the Contacts List. (p. 31)
To use a phone number or e-mail address in the Contacts List, press [Options] and select “Contacts List” in step 2.*
- *To save the message without sending, select “Save to Drafts” instead in step 3.*
- *To enter the subject, select “Subject” in step 3 and enter it. Up to 40 characters as the subject (and up to 20 recipients (for To and Cc)) can be entered. However, these may be limited depending on your network. In this case, you may not be able to send MMS. Contact your network operator for more information.*

- To add more recipients, select “Add Contact” in step 3. Select “To” or “Cc” and select the desired number of the recipient. Then enter the phone number or e-mail address.

To Send a Message Template MMS

Your phone provides message templates with an image and voice attachment that help you create easily.

 → “Multimedia” → “Create Message” → [Options] → “Message Template”

A confirmation screen asking whether you wish to discard the current text is displayed.

1. Confirm by selecting [Yes] or [No].
2. Select the desired template.
3. Enter the message.
4. Enter the phone number or e-mail address of the recipient.
5. Select “Send”.

Note

- Selecting “Message Template” deletes messages or images you have entered or attached. To prevent deletion, select “Message Template” first, then enter messages.

Turning the Slide Show Setting On or Off

 → “Multimedia” → “Settings” → “Slide Show”

1. Select “On” or “Off”.

If You Select “On”

- You can create messages which have up to 10 slides. Each slide can contain one picture, one sound file and up to 1000 characters of text (up to the message total 30 Kbytes or 100 Kbytes limit).
- If you wish to add a slide to a single slide, press [Options] and select “Add Slide”.
If you wish to perform slide operations for multiple slides, press [Options] and select “Slide Control”.
The slide control options available are:
Add: To add a new slide.
Remove: To remove the active slide.
Previous: To navigate to the previous slide.
Next: To navigate to the next slide.
- Video clip data cannot be attached as slide data to the message.

If You Select “Off”

- You can attach a maximum of 20 pictures, sounds or video clips and up to 2000 characters of text (up to the message total 30 Kbytes or 100 Kbytes limit).

Inserting Attached Data

You can send pictures, sounds and video clips saved in the handset memory attached to multimedia messages. When attaching video clips, “Slide Show” must be set to “Off”.

 → “**Multimedia**” → “**Create Message**” → [Options]

1. Select from “Picture”, “Sound” or “Video”.
2. Select from “Saved Pictures”, “Saved Sounds” or “Saved Videos”.
3. Select the desired file.

The selected picture/sound/video clip is attached. When attaching is complete, press [Back] to return to the message creation screen.

- To add more files, press [Options] and select from “Add Picture”, “Add Sound” or “Add Video”. Then select from “Saved Pictures”, “Saved Sounds” or “Saved Videos”, and select the desired file.
- To remove the attached files, press [Options] and select “Remove”.

Note

- Pictures/Sounds/Video clips protected with a copyright cannot be sent attached to a message.
- Instead of performing step 2, you can send data recorded with “Take Picture”, “Record Voice” or “Record Video” options.

Reading MMS

Messages you receive are stored in the Inbox.

Incoming Messages

The MMS indicator () will appear when you are receiving an incoming message.

 → “**Multimedia**” → “**Inbox**”

1. Select the message you wish to view.
The message is displayed.
2. Scroll the screen to read the message.
3. Press  when finished.

Tip

- The volume varies depending on the Multimedia Volume settings (p. 91). The sound is deactivated when “Multimedia Volume” is set to “Silent”.

Storing the Phone Number or E-mail Address of a Sender in the Contacts List

 → “Multimedia” → “Inbox”

1. Highlight the message from which you want to store the phone number or e-mail address.
2. Press [Options] and select “Save Sender”.
For details on entering a name, see “Add New Contact” on page 30.

Retrieving MMS

 → “Multimedia” → “Inbox”

When “” is in the Inbox, the following can be done.

1. Highlight the alert you wish to download.
2. Press [Options] and select “Download”.

Tip

- You can press  instead of step 2 to start downloading.

Confirming Arrival of Delivery Report

 → “Multimedia” → “Sent”

1. Highlight the message of which you wish to confirm arrival of delivery report.
2. Press [Options] and select “Delivery Report”.
This menu is available only for sent messages that have the “Delivery Report” set to “On”. For details

on selecting “Delivery Report”, see “Setting Up MMS”.

Setting Up MMS

 → “Multimedia” → “Settings”

1. Select the item you wish to set up.
 - Roam. Download (Immediate, Deferred):
Controls MMS download timing when roaming outside of your network.
Immediate: Downloads MMS immediately from the server.
Deferred: Asks if you would like to download from the server.
 - Delivery Rep. Allow (On, Off):
Enables or disables Delivery Report when receiving a message which applies to the Delivery Report function.
 - Anonymous Reject (On, Off):
Rejects a messages from an unknown or empty address name or not.
 - Auto Delete (Off, Inbox, Sent, Both):
Deletes the oldest message automatically, when the Inbox, Sent or both (Inbox and Sent) is full.

- Slide Show (On, Off):
Enables or disables Slide Show when sending a message.
- Message Size (30 KB, 100 KB):
Sets the maximum message size that can be sent. The maximum message size that can be sent differs according to the network operator. Contact your network operator for more information.
- Advanced
 - Priority:
Prioritises composed messages.
 - Delivery Report:
Enables Delivery Report.
 - Expiry Time:
Sets Expiry Time for a message to be stored in the Server.
 - Sender Visibility:
Displays the information about the sender.
 - Slide Interval:
Sets the slide display time when sending a message.

2. Change each item.

Sending a Picture File with Postcard

Your phone allows you to send multimedia messages to a Vodafone specific Postcard service centre that prints the picture and mail it to the recipient's home address specified in the MMS message. (Your phone is initially provided with the address of a Vodafone specific Postcard service centre, and its address cannot be changed.)

Note

- *This service is not available on some service providers. Please contact your service provider for more information.*

To Create a New Postcard

 → **“Multimedia”** → **“Postcard”**

1. Select “Saved Pictures”.
2. Select a picture you wish to use for a postcard.
3. Enter your message.
4. Enter the following information for the recipient.
See the note below for details.
 - Name
 - Postcode
 - Additional Info
 - County / City
 - House No. / Street
 - Country
5. Press [Options] and select “Send”.

Note

- *Instead of performing step 1, you can use data taken with the “Take Picture” option.*
- *The items Name, House No. / Street and Postcode are necessary to complete sending Postcards.*
- *Information for a recipient*

Name (mandatory):

Name of the recipient for a postcard up to 50 characters

Additional Info (optional):

Additional information of the recipient up to 50 characters

House No. / Street (mandatory):

Street and number up to 50 characters

Postcode (mandatory):

Postal code up to 60 characters

County / City (optional):

State, province, and region up to 50 characters

Country (optional):

Country up to 20 characters

- *The item “Country” may not be displayed, so you cannot send Postcards overseas from your phone.*
- *Files in Animation GIF format cannot be used for the Postcards service.*
- *The picture quality of Postcards varies depending on the picture size.*

Text (SMS) (M 4-3)

About Text Messaging

The Short Message Service (SMS) allows you to send text messages of up to 1024 characters to other GSM users.

To Use SMS with Your Phone

Messages longer than 160 characters may be composed. During sending, the messages are split. If the receiver has a suitable phone the messages recombines during reception, if not your message appears as a number of separate 152 characters messages.

You can send or receive SMS even if you are talking on the phone.

You can also use Text Templates to help you compose SMS.

Creating and Sending a New SMS (M 4-3-1)

 → “Text” → “Create Message”

1. Enter your message.

To use the text template, move the cursor to the point you wish to insert the template. Press [Options] and select “Text Template” and then select the desired template.

2. Enter the phone number of the recipient.
3. Select “Send”.

The phone begins the sending process and the SMS is sent. After the message has been sent, the message is added to the Sent box.

To save the message in the Drafts box without sending it, select “Save to Drafts”.

Note

- When you send a message of more than 160 characters, the confirmation message is displayed.

Tip



- You can use the phone number from the Contacts List. (p. 31)
To use a phone number in the Contacts List, press [Contacts] in step 2.
- To add more recipients, select “Add Contact” in step 3. Select an item number for adding the recipient’s phone number. Then enter the phone number.

Reading SMS

Incoming Messages

The SMS indicator () will appear when an incoming message arrives.

1. When you receive a SMS, press  during stand-by.
2. Select the message you wish to view.

The sender’s phone number and a part of the message are displayed. When the sender’s phone number is stored in the Contacts List, the sender’s name is displayed instead of the phone number. Messages that are marked with “” denote unread messages. If the Inbox, Sent box or Drafts box is full, “” is displayed. Delete unnecessary messages.

3. Scroll the screen to read the message.
4. Press  when finished.

Extracting Phone Numbers from the Received Messages and Making a Call

You can make a call using the phone number embedded in the received SMS message.

☐ → *“Text”* → *“Inbox”*

1. Select the message from which you wish to extract phone numbers.
2. Press [Options] and select “Extract Numbers”.
Telephone numbers embedded in the message are displayed.
3. Highlight the phone number.
4. Press [Options] and select “Make Call”.
To save this phone number in the Contacts List, select “Save Number”.

Setting Up SMS (M 4-3-5)

To Set Up the Service Centre Address

☐ → *“Text”* → *“Settings”* → *“Message Centre”*

1. Enter the centre phone number.
If you wish to enter a country code for a message to an international number, press and hold  until a “+” sign is displayed.

Message Lifetime

This indicates the number of days and hours for which a message you send may remain undelivered to the message recipient.

During this period, the message service centre will continually try to deliver the message to the recipient.

☐ → *“Text”* → *“Settings”* → *“Message Lifetime”*

1. Select the validity period.

Message Format

☐ → *“Text”* → *“Settings”* → *“Message Format”*

1. Select the message format.

Connection Type

☐ → *“Text”* → *“Settings”* → *“Connection Type”*

1. Select the connection type.

Optimisation

When set “On” (default), double-byte characters such as European characters with an accent are converted into single-byte characters and sent.

When “Off”, double-byte characters are sent as displayed.

Please note that you may be charged double for double-byte characters sent in an SMS when Optimisation is set “Off”.

 → “Text” → “Settings” → “Optimisation”

1. Select “On” or “Off”.

Cell Broadcasts (M 4-7)

You can receive Cell Broadcast messages or general messages such as weather forecasts and traffic reports. This information is broadcast to subscribers in certain network areas.

This function may not be available on all mobile phone networks. Contact your network operator for more information.

Enabling/Disabling Cell Broadcasts (M 4-7-1)

 → “Cell Broadcasts” → “Switch On/Off”

1. Select “On” or “Off”.

Reading Cell Broadcast Messages (M 4-7-2)

 → “Cell Broadcasts” → “Read Messages”

1. Select the desired subject.
2. Scroll the screen to read the message.
3. Press [Back].

Setting Languages

You can select your preferred language for the cell broadcast message display.

 → “Cell Broadcasts” → “Settings” → “Language”

The current language is displayed.

1. Press .

The language list is displayed.

2. Select the desired language.
3. Press [Back].

Subscribing to Cell Broadcasts

Select the page of the cell broadcast message that you want.

 → “*Cell Broadcasts*” → “*Settings*” → “*Set Info Subjects*”

1. Select “Add/Remove”.
2. Select the desired page.
3. Press [Back].

Tip

- *If the desired page is not in the list that appears in step 2, select “Create Subject” in step 1, then enter the subject code to add a page. For details on the subject code, contact your service provider.*

Vodafone live! (M 2)

Your phone is already configured to access Vodafone live! and the mobile internet*.



Vodafone live! is a new mobile internet portal which is your gateway to a new world of information, games, music and services.

Because your phone uses GPRS, a system that is much faster than previous ways of getting mobile information. Also, the connection is 'always on' which means there is no need to wait for dialling up. You only have to pay for the data you send or receive, not how long you're connected.

* If you have problems getting connected, please phone Vodafone Customer Support.

Your phone contains a WAP browser used for surfing on the Mobile Internet, where you can get a lot of useful information. Normally, pages are designed for a mobile phone.

Your phone is already setup to Vodafone site for WAP/MMS Settings.

BROWSER BY



OPENWAVE











Starting the WAP Browser

1. Press  during stand-by.

To Exit the WAP Browser

1. Press  to exit the browser.

Navigating a WAP Page

- : Move the highlights around in the screen.
- : Executes the option displayed in the lower centre of the screen.
- : Launches browser option menu.
- : Selects an action displayed in the lower right corner of the screen. Used to access “Vodafone live!” by opening the browser.
-  (press and hold): Starts the “Go to URL”.
-  to  (press and hold): Starts the Bookmark (WAP).
- : Exits the browser (short press). Turns off the phone. (press and hold)

Browser Menu

When you are browsing, you can reach browsing options by pressing [Options].

- Select:
Selects the link you wish to see. (“Select” is displayed only when the link is highlighted.)
- Home:
Goes to the homepage you set in the WAP Settings.
- Add bookmark:
Adds the site you are currently browsing to your list of bookmarks.
- View bookmarks:
Displays a list of bookmarks.
- Save items:
Saves pictures, sounds or video clips in the appropriate My Items folder.
- Go to URL:
Inputs the URL of the site you wish to go to.
- History:
Displays a history list.
- Forward:
Moves to the next URL in the history list.

- Reload page:
Refreshes the contents of the WAP page.
- Advanced...:
 - Show URL:
Displays the URL of the site you are currently browsing.
 - Save page:
Saves the page you are currently browsing to your list of Snap Shots.
 - Snapshots:
Displays a list of Snap Shots.
 - Alert inbox:
Displays a list of WAP push messages. You can receive push messages via WAP Services. This means that a service provider sends WAP content to your phone, without any set up.
 - Settings:
Includes “Downloads”, etc.
 - Security:
Sets the security.
 - Clear...:
Clears history, cache, etc.
 - Restart Browser:
Restarts the browser.

Bookmarks

When you are browsing, press [Options] and select the appropriate option.



To Add a Bookmark

1. Select “Add bookmark”.

To Access Bookmarked Pages

1. Select “View bookmarks”.
2. Select the desired bookmark.

To Edit Bookmarks

1. Select “View bookmarks”.
2. Select “More...”.
3. Highlight a bookmark page you wish to edit.
4. Press [Options] and select “Details”.
5. Edit the title, then press .
6. Edit the URL, then press .
7. Select “Save”.

To Delete Bookmarks

1. Select “View bookmarks”.
2. Select “More...”.
3. Highlight a bookmark page you wish to delete.
4. Press [Options] and select “Delete”.
5. Press [Options] and select “OK”.

Setting the Hotkeys to Web Page Bookmarks

You can access Web pages quickly by pressing the shortcut keys (hotkeys). Follow the following to assign shortcuts.

1. Select “View bookmarks”.
2. Select “More...”.
3. Highlight a bookmark page you wish to edit.
4. Press [Options] and select “Hotkeys”.
The list of hotkeys is displayed.
5. Select the number to which you wish to assign hotkeys.
The list of registered bookmarks is displayed.
6. Select the desired bookmark.

My Items (M 6)

My Items contains several types of picture, sound and video clip data. Also included in My Items are frequently used text message phrases and accessed WAP pages (addresses) which you can use. You can also transmit picture, sound and video clip data via infrared or *Bluetooth* wireless technology to OBEX-enabled phones.

Note

- *The phone can store approximately 1.8 Mbytes of data across Pictures, Games & More, Sounds and Videos.*

Pictures (M 6-1)

Pictures that are taken by a digital camera or images that are downloaded from mobile Internet sites can be managed. You can register pictures in the following formats: JPEG, PNG, BMP, GIF, WBMP, and WPNG.

Viewing Pictures

“My Items” → “Pictures” → “Saved Pictures”

1. Select the file you wish to view.
The selected picture is displayed.

Using Images as Wallpaper

“My Items” → “Pictures” → “Saved Pictures”

The list of pictures is displayed.

1. Highlight the file you wish to use as wallpaper.
2. Press [Options] and select “Set as Wallpaper”.
3. Specify the area you wish to display using the navigation keys.

Saving to Contacts List

You can use this option only for pictures saved in the handset memory.

“My Items” → **“Pictures”** → **“Saved Pictures”**

1. Highlight the file you wish to add to Contacts List.
2. Press [Options] and select “Add to Contact”.

To overwrite, select “Existing Contact” and select the data you wish to save to.

If the picture size exceeds 120 dots in width or 160 dots in height, specify the area you wish to display.

To save as a new entry, select “New Contact”.

For details on entering a name, see “Add New Contact” on page 30.

Editing Pictures

“My Items” → **“Pictures”** → **“Saved Pictures”**

1. Highlight the file you wish to edit.
2. Press [Options] and select “Edit”.
3. Select the desired option:

“Rotate”: The picture is rotated 90° anticlockwise. Press [Rotate] again for another 90°.

“Adjust Size”: Select the desired option.

“Retouch”: Select the retouching option.

“Add Frame”: Select the desired frame pattern.

“Add Stamps”: Press [Stamps] and select the desired stamp pattern. Repeat this step to add more patterns.

Note

- *The size of pictures that you can retouch is 52 dots [W] × 52 dots [H] minimum.*
- *The size of pictures that you can add stamps to is 24 dots [W] × 24 dots [H] minimum.*
- *Images exceeding 120 [W] or 160 [H] are saved as 120 [W] × 160 [H] regardless of the original size.*
- *“Adjust Size” may not be available depending on the original picture and copyright issued.*

Sending a Picture File

“My Items” → **“Pictures”** → **“Saved Pictures”**

1. Highlight the file you wish to send.
2. Press [Options] and select “Send”.
3. Select “As Multimedia” or “As Postcard”.

For details on creating a message, see “Creating a New MMS” on page 44.

Note

- *The Postcard service is not available on some service providers. Please contact your service provider for more information.*
- *Pictures protected with a copyright cannot be sent attached to a message.*

Tip

- *For details on transmitting My Items data, see “Sending My Items Data” on page 64.*

Uploading Picture Files

You can upload your pictures to the Media Album.

Note

- *This service is not available on some service providers. Please contact your service provider for more information.*

“My Items” → “Pictures” → “Saved Pictures”

1. Highlight the file you wish to upload.
2. Press [Options] and select “Send”.
3. Select “To Album”.
4. Press [Yes].

Note

- *Pictures protected with a copyright cannot be uploaded.*

Downloading Picture Files (M 6-1-3)

“My Items” → “Pictures” → “More Pictures”

The picture file download site is displayed.

Games & More (M 6-2)

Along with the preloaded application, downloaded applications are stored in Applications.

Note

- *Applications can store up to 50 applications.*

Using Applications

Various kinds of Vodafone specific applications can be used in this phone.

To use applications, download the applications via the mobile Internet.

Some applications offer the ability to connect to a network either within a game or network based application.

Note

- *Applications may be both localised (no connectivity) and network based (using the mobile Internet to update information/play games). The network may charge you more for using network-based applications. Please contact your service provider for more information.*

Downloading Applications

Confirmation Screen

Before downloading the application you are asked to confirm what you are about to receive.

After checking the information on the confirmation screen, the application can be downloaded.

Note

- *User authentication may be required before downloading the application on some information screens.*

Executing Applications (M 6-2-1)



“My Items” → “Games & More” → “Applications”

Downloaded applications are sequentially displayed from the latest one.

1. Select the title of the application you wish to execute.
The selected application is executed.
When using network connection type applications, connection to the network can be selected.
2. To end the application, press  and select “End”.









More Games (M 6-2-2)

“My Items” → “Games & More” → “More Games”

1. Select the application you wish to download.
After a WAP browser is displayed variously, the confirmation screen will appear after a whilst.
2. Press  to start downloading.
3. Press  when finished.

Sounds (M 6-3)

The ringtones created using the Melody Editor and the AMR data recorded by Voice Recorder are managed in Saved Sounds. The default ringtones are not contained within Saved Sounds.

-  SMF: SMAF format
-  *MIDI: Original ringtone (composed in Melody Editor)
-  MIDI: Standard MIDI format
-  IMV: i Melody format
-  WAV: WAVE format
-  AMR: AMR format
-  : Original voice clip (AMR format recorded in Voice Recorder)

Tip

- *SMAF (Synthetic music Mobile Application Format) is a format of music data for mobile phones.*

Playing Back Sound Files

“My Items” → “Sounds” → “Saved Sounds”

1. Select the file you wish to play back.
To stop playback, press .

Note

- *This option may not be available in all regions.*
- *The volume varies depending on the Multimedia Volume settings (p. 91). The sound is deactivated when “Multimedia Volume” is set to “Silent”.*

Using the Sound Files as Ringtone

“My Items” → “Sounds” → “Saved Sounds”

1. Highlight the file you wish to use as ringtone.
2. Press [Options] and select “Set as Ringtone”.
The selected sound is automatically used for the ringtone of the current Profiles.

Note

- *Files in AMR or WAVE format cannot be used for the ringtone.*

Sending a Sound File with MMS

“My Items” → “Sounds” → “Saved Sounds”

1. Highlight the file you wish to send.
2. Press [Options] and select “Send”.
3. Select “As Multimedia”.
If you select your original ringtone in step 1, perform the following.
4. Select the file format “SMAF”, “MIDI” or “i Melody”.
For details on creating a message, see “Creating a New MMS” on page 44.

Note

- *Sounds protected with a copyright cannot be sent attached to a message.*
- *Only the first part of the data is converted if you select “i Melody” in step 4.*

Uploading Sound Files

You can upload your sounds to the Media Album.

Note

- *This service is not available on some service providers. Please contact your service provider for more information.*

“My Items” → “Sounds” → “Saved Sounds”

1. Highlight the file you wish to upload.
2. Press [Options] and select “Send”.
3. Select “To Album”.
If you select your original ringtone in step 1, perform the following, otherwise go to step 5.
4. Select the file format “SMAF”, “MIDI” or “i Melody”.
5. Press [Yes].

Note

- *Sounds protected with a copyright cannot be uploaded.*

Downloading Sound Files (M 6-3-4)

“My Items” → “Sounds” → “More Sounds”



The sound file download site is displayed.

Videos (M 6-4)





Video clips that are recorded by a video camera or video clips that are downloaded from mobile Internet sites can be managed.

Playing Back Video Clip Files

“My Items” → “Videos” → “Saved Videos”

1. Select the file you wish to play back.
2. Press .
To resume, press  again.
To stop playback, press [Back].

Note

- *The volume varies depending on the Multimedia Volume settings (p. 91). The sound is deactivated when “Multimedia Volume” is set to “Silent”. To adjust the volume, press  (or ) or  (or ).*
- *Video clips exceeding 128 dots [W] or 96 dots [H] can be displayed in original or half size by pressing [$\times 1$] or [$\times 1/2$].*

Sending a Video Clip File with MMS

“My Items” → **“Videos”** → **“Saved Videos”**

1. Highlight the file you wish to send.
2. Press [Options] and select “Send”.
3. Select “As Multimedia”.

For details on creating a message, see “Creating a New MMS” on page 44.

Note

- *Video clips protected with a copyright cannot be sent attached to a message.*

Uploading Video Clip Files

You can upload your video clips to the Media Album.

Note

- *This service is not available on some service providers. Please contact your service provider for more information.*

“My Items” → **“Videos”** → **“Saved Videos”**

1. Highlight the file you wish to upload.
2. Press [Options] and select “Send”.
3. Select “To Album”.
4. Press [Yes].

Note

- *Video clips protected with a copyright cannot be uploaded.*

Downloading Video Clip Files (M 6-4-3)

“My Items” → **“Videos”** → **“More Videos”**

The video clip file download site is displayed.

Sending My Items Data

Choose the appropriate menu.

“My Items” → **“Pictures”** → **“Saved Pictures”**

“My Items” → **“Sounds”** → **“Saved Sounds”**

“My Items” → **“Videos”** → **“Saved Videos”**

1. Highlight the desired file.
2. Press [Options] and select “Send”.
3. Select “Via Bluetooth” or “Via Infrared”.

For “Via Bluetooth”

The phone starts searching for *Bluetooth* wireless technology enabled devices within 10 metres.

When detected, a list of enabled devices is displayed allowing you to select the desired device. The connection can be established and the file sent.

For “Via Infrared”

The phone starts searching for an infrared-enabled device within 20 centimetres.

When detected, the infrared connection is established and the file is sent.

Note

- *Pictures/Sounds/Video clips protected with a copyright cannot be sent.*
- *When pairing, you need to enter your passcode when establishing contact with a Bluetooth wireless technology enabled device for the first time.*

Receiving the My Items Data

When the phone receives the My Items data, a confirmation message appears in the stand-by mode screen.

1. Press [Yes].

The received data is registered in the corresponding My Items folder.

Tip

- *For details on Infrared or Bluetooth wireless settings, see “Connectivity” on page 85.*

Text Templates (M 6-5)

You can register up to 20 text templates for use in text messages and multimedia messages.

120 characters may be registered in any text template.

Adding Phrases to Text Templates

“My Items” → “Text Templates”

1. Select the number you wish to register.
2. Enter the text and press .

Editing Text Templates

“My Items” → “Text Templates”

1. Highlight the text template you wish to edit.
2. Press [Options] and select “Edit”.
3. Enter new text and press .

Viewing Text Templates

“My Items” → “Text Templates”

The list of Text Templates is displayed.

1. Highlight the text template you wish to view.
2. Press [Options] and select “View”.

Deleting Text Templates

“My Items” → “Text Templates”

1. Highlight the text template you wish to delete.
2. Press [Options] and select “Delete”.

Memory Status (M 6-7)

This function helps you to check the memory status of My Item. Memory status covers Applications, Pictures, Sounds, and Videos.

“My Items” → “Memory Status”

Games & More (M 1)

Applications (M 1-1)

The list of Java™ applications is displayed.

Downloaded applications are displayed in order starting from the latest one.

Executing Applications

For details on executing applications, see “Executing Applications” on page 61.

Setting Permission

When using Java™ applications that access the network, online security for monetary transactions can be set with this option.

To Select the Function and Confirmation Method
“Games & More” → *“Applications”*

1. Highlight the desired Java™ application.
2. Press [Options] and select “Permission”.
3. Select “Network Access” to set how the Java™ application accesses the network.
4. Select the desired confirmation method.

Always Connect: Allows the Java™ application access without confirmation.

First Time: Informs you when the Java™ application accesses the network for the first time. If allow is selected, no more confirmations are made until you delete the application.

Per Session: Informs you when the Java™ application accesses the network for the first time. If allow is selected, no more confirmations are made until the application finishes operation.

Per Access: Informs you every time the Java™ application accesses the network regardless of whether or not you select allow or deny.

Never Connect: Prevents the Java™ application from accessing the network and no confirmation is made.

To Reset Permissions

You can reset all permissions you made

“Games & More” → “Applications”

1. Highlight the desired Java™ applications.
2. Press [Options] and select “Permission”.
3. Select “Reset Permissions”.

Screensavers (M 1-2)

You can download screensaver applications for the stand-by screen.

“Games & More” → “Screensavers” → “Switch On/Off”

1. Select “On” or “Off”.

Note

- *If you select “On” and a screensaver application is not set, a list displaying available screensavers appears, asking you to make a selection.*

Set Application (M 1-2-2)

“Games & More” → “Screensavers” → “Set Application”

The downloaded applications are displayed.

1. Select the desired screensaver application.

Resume Time (M 1-2-3)

You can set the time period for the screensaver application to activate.

“Games & More” → “Screensavers” → “Resume Time”



1. Enter the resume time in two digits using the digit key.

More Games (M 1-3)

You can download applications.

“Games & More” → “More Games”

The application download site is displayed.

1. Select the application you wish to download.
After a WAP browser is displayed variously, the confirmation screen will appear after a whilst.
2. Press  to start downloading.
3. Press  when finished.

Settings (M 1-4)

Calls & Alarms (M 1-4-1)

You can set the priority of incoming calls and alarms whilst an application is operating.

“Games & More” → “Settings” → “Calls & Alarms”





1. Select “Incoming Call” or “Alarm”.
2. Select methods.
 - “Call Priority” or “Alarm Priority”:
The application is suspended automatically, and you can receive a call, or the alarm will sound. After finishing the call or the alarm ends, the suspend icon (🔇) is displayed letting know there is a suspended application.
 - “Call Notice” or “Alarm Notice”:
The marquee (character scrolls) is displayed on the first line of the screen whilst the application continues. If you press , the application is suspended, and you can receive a call. After finishing the call, the suspend icon (🔇) is displayed letting know there is a suspended application.

Sound Volume (M 1-4-2)

You can set the volume of the application such as sound effect to one of the five levels or silent. When “Multimedia Volume” (p. 91) is set to “Silent”, this setup has priority.

“Games & More” → “Settings” → “Sound Volume”

The current volume level is displayed.

1. Press  (or ) to increase the volume or press  (or ) to decrease the volume and then press .

Backlight (M 1-4-3)

“Games & More” → “Settings” → “Backlight” → “Switch On/Off”

1. Select from “Always On”, “Always Off” or “Default Settings”.
 - “Always On”: Lit whilst the application is operated.
 - “Always Off”: Unlit whilst the application is operated even if a key is pressed.
 - “Default Settings”: Works with the main backlight setting. (p. 95)

To Set the Blinking Operation

This setting enables the backlight to be controlled by the application. If set to “Off”, the backlight cannot be turned on from the application.

“Games & More” → **“Settings”** → **“Backlight”** → **“Blink”**

1. Select “On” or “Off”.

Vibration (M 1-4-4)

When the vibrator is set in the application, you can choose whether the operation is enabled or disabled.

When a SMAF file is specified in the application, you can operate the vibrator set in the SMAF file.

Note

- *SMAF (Synthetic music Mobile Application Format) is a music data format for mobile phones.*

“Games & More” → **“Settings”** → **“Vibration”**

1. Select from “On”, “Off” or “On & Link to Sound”.
When you set “On & Link to Sound”, the vibration is synchronised with the sound of SMAF file in the application.

Set to Default (M 1-4-5)

To Reset All Items in Settings Menu

“Games & More” → **“Settings”** → **“Set to Default”**

1. Enter your handset code.

The default handset code is “0000”. For details on changing the handset code, see “To Change Handset Code” on page 105.

Java™ Information (M 1-5)

The information about the licenses belonging to Java™ is displayed.

Applications (M 3)

SIM Application (M 3-1)

You can refer to the information on the SIM. Contact your service provider for further details.

Alarms (M 3-2)

Setting the Alarms

The alarm function allows you to be alerted at a specified time.

Note that the alarm may not function correctly if the clock has not been set.

Note

- *The alarm functions even if the phone is switched off.*
- *The alarm will not ring when “Ringer Volume” (p. 88) is set to “Silent”.*

“Applications” → “Alarms”

1. Select the blank setting.
2. Enter the desired time.

To Change the Type of Alarm Tone

3. Select “Set Alarm Tone”.
4. Select “Tone”.
5. Select “Preset Sounds” or “My Sounds”.

6. Select the desired tone.

For details on selecting a tone, see “Assigning Ringtone” on page 89.

To Change the Vibration of Alarm Tone

7. Select “Vibration”.
8. Select “On”, “Off” or “On & Link to Sound”.
For details on selecting a vibration, see “Vibration” on page 89.

To Change the Duration of Alarm Tone

9. Select “Duration”.
10. Enter the desired time (02-59).
11. Press [Back].

To Set the Repeating Option

12. Select “Repeat Daily”.
13. Select “On” or “Off”.
14. Press [Save].

Editing the Alarm Setting

“Applications” → *“Alarms”*

1. Select the desired setting and edit it.

Resetting an Alarm Setting

“Applications” → *“Alarms”*

1. Select the alarm you wish to reset.
2. Select “Reset Alarm”.

Resetting All Alarm Settings

“Applications” → *“Alarms”* → *“Clear All”*

Calculator (M 3-3)

The calculator function performs the 4 arithmetic calculations using up to 12 digits.

“Applications” → *“Calculator”* → *“Calculator”*

The calculator is displayed on the display.

Key operations for calculation are as follows.



To enter a decimal point, press .

To clear the entered number or operand, press [Clear].

To do the calculations, press .

To start a new calculation, press [Clear].

Rate Conversion (M 3-3-2)

You can also use the calculator as a currency calculator to convert from/to a home currency using a conversion rate that you enter.

To Set a Currency Conversion Rate

“Applications” → **“Calculator”** → **“Exchange Rate”**

1. Select “Foreign -> Domestic” or “Domestic -> Foreign”.
2. Enter the currency conversion rate.
To delete all digits, press [Clear].

To Convert a Value

“Applications” → **“Calculator”** → **“Calculator”**

1. Enter the value to be converted.
2. Press [Options] and select “In Domestic” or “In Foreign”.
The result is displayed.
If you select “Exchange Rate” in step 2, you can set a currency conversion rate.

Note



- You cannot perform step 2 when an arithmetic symbol (+, -, × or ÷) is displayed.

Voice Recorder (M 3-4)

This allows you to record a voice clip of up to 30 seconds, which can be used to remind you of schedule entries or be sent within a multimedia message. The recorded voice clip is registered in Saved Sounds. Voice clips are saved in “.amr” format.





Recording a Voice Clip

“Applications” → **“Voice Recorder”**



1. Press  to start recording.
To stop recording before the recording time is over, press .
2. Select “Save” to save the voice clip.
To play back the recorded voice clip, select “Playback”.
To record a voice clip again, press [Cancel] .

Note

- To change recorded size before recording, press [Options] and select “Record Size”. Then select “Extended Voice” or “For Message”.
- When the Message Size described on page 48 is set to “100 KB”, “Record Size” is not displayed.



- The volume varies depending on the Multimedia Volume settings (p. 91). The sound is deactivated when “Multimedia Volume” is set to “Silent”. To adjust the volume, press  (or /the side-up key) or  (or /the side-down key).

Tip

- You can also activate Voice Recorder by pressing , then  during stand-by.

Sending Voice Clips

“Applications” → “Voice Recorder”

1. Press  to start recording.
2. Press  to stop recording.
3. Select “Save and Send”.

For details on creating a message, see “Creating a New MMS” on page 44.

Note

- “Save and Send” is not displayed after recording in extended voice mode.

Melody Editor (M 3-5)

You can create an original ringtone, or you can send a melody attached to a multimedia message.

You can input up to 95 tones × 32 voices, 190 tones × 16 voices, or 380 tones × 8 voices per melody.

The original ringtone is registered in Saved Sounds.

Creating Your Original Ringtone (M 3-5-1)





“Applications” → “Melody Editor” → “Create New”

1. Enter the title.

Up to 24 characters can be entered.

2. Select a tempo.



The music tempo is described below.

- “Allegro (Fast)”:  150
- “Moderato (Normal)”:  125
- “Andante (Slow)”:  107
- “Adagio (Very Slow)”:  94

3. Select from “8 Chords”, “16 Chords” or “32 Chords”.

4. Press the digit keys to specify the musical scale and rest.

For details on specifying the sound level and rest, see “To Specify the Musical Scale and Rest” on page 76.

5. Press  or  to specify the types of musical notes or rest.

For details on specifying the musical notes and rest, “To Specify the Types of Notes and Rests” on page 76.

6. Press  after inputting one note.

Input the next note after the cursor moves to the right.

7. Repeat steps 4 to 6 to input notes.

When entering notes, you can do the following:

- Press  to play back all input notes.
- Press [Options] and select:
 - “Play bef. cursor” to play back notes up to the cursor position.
 - “Select Part” to select another chord.
 - “Set Tone” to set or change the tone using different instruments. (p. 77)
 - “Set Strength” sets the strength of the tone. (p. 77)

8. When you finish inputting, press [Options] and select “Save”.

9. Select “Save to My Items”.

Note

- *The volume varies depending on the Multimedia Volume settings (p. 91). The sound is deactivated when “Multimedia Volume” is set to “Silent”.*
- *If the capacity or memory in Saved Sounds becomes insufficient, the message, “Maximum capacity : 200 Not registered.” or “Not registered. Memory full.” is displayed. The screen returns to step 9. Try again after deleting unnecessary data.*
- *Melodies consisting of too many short notes (semiquavers and triplets) cannot be played back in step 8 and the following message is displayed: “Can not play due to too many notes per sec.” The screen returns to step 5. The message “Can not save due to too many notes per sec.” may also be displayed, and the screen returns to step 5. Reduce the number of melodies, replace short notes, cancel triplets, etc. to remedy.*

To Specify the Musical Scale and Rest

Using the keys shown below, specify the musical scale and rest.

Do	Re	Mi	Fa	Sol	La	Ti	Rest
1	2	3	4	5	6	7	0

When you press the key shown above once, a crotchet is specified in the middle scale (no mark).

When you press the same key repeatedly, the note will shift cycle through the available octave ranges.

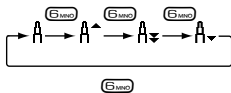

When you press or whilst a note is selected, the note will move one semitone higher or lower.

When entering rest, crotchet rest is entered.

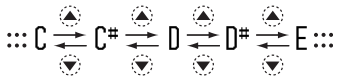

To Specify the Types of Notes and Rests

Press or repeatedly.

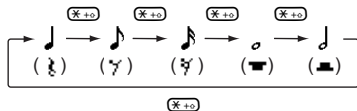

When you make a dotted note or a triplet, press after selecting the target note.

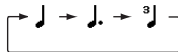

Note

- You cannot make a dotted semiquaver (semiquaver rest) or a dotted semibreve (semibreve rest).
- Three continuous notes are required for a triplet.

To specify a tie, press after selecting the target notes.

An underscore () is displayed next to the note, and the note is tied with the next one.

To enter the next note, press to move the cursor to the right. Then, repeat the operation on the previous pages.

If the cursor is positioned next to a note, you can repeat the note immediately left of the cursor when ▲ or ▼ is pressed.

To Set the Tone

The phone can play notes using different instruments.

You can select from 128 basic tones (8 types of: Pianos, Chimes, Organs, Guitars, Basses, Strings 1, Strings 2, Brasses, Reeds, Flutes/Pipes, Synth Leads, Synth Pads, Synth Effects, Ethnics, Percussions, and Effects) and 61 extended tones (40 types of Drums (FM) and 21 types of Drums (WT)).

1. Press [Options] and select “Set Tone” in step 8 on page 75.
2. Press ▲ or ▼ to highlight a category of the tone.
3. Press ▲ or ▼ to highlight a tone.
4. Press ●.

Now you can create an original ringtone.

Tip

- You can play back the melody in the selected tone by pressing [Options] and select “Play Current Part” in step 4, or play back the syllable names in the selected tone by selecting “Confirm Tones” instead.

To Set the Strength of the Tone

The strength of the tone can be set in 3 levels for each part.

When you purchase this phone, the strength of the tone is set to “Loud”.

1. Press [Options] and select “Set Strength” in step 8 on page 75.
2. Select a strength of the tone.

Now you can create an original ringtone.

Editing Original Ringtones (M 3-5-2)

“Applications” → “Melody Editor” → “My Sounds”

1. Highlight an original ringtone you wish to edit.
2. Press [Options] and select “Edit Melody”.
3. Edit the title.
4. Select a tempo and number of voices.

5. Edit the data.
6. When you finish editing, press [Options] and select “Save”.
7. Select “Save to My Items”.
8. Select “Overwrite” or “New”.

Note

- *When the number of voices is modified in step 4, the confirmation message may be displayed. When you press [Yes], a section of the melody may be deleted.*

Tip

- *You can delete the melody after or before the cursor by pressing [Options] and selecting “Del. after cursor” or “Del. before cursor”.*

Copying and Pasting Notes

You can copy and move a part of the melody to another position.

Only original ringtones or editable melodies can be copied or moved.



1. In the Score input screen, press [Options] and select “Copy” or “Cut”.
2. Move the cursor to the first note to be copied or to be cut.

3. Move the cursor to the last note to highlight the area.
4. Press [Options] and select “Paste”.
5. Move the cursor to the point you wish to paste the notes.

Phone Help (M 3-6)

You can view the help list and use it to guide you in the phone’s functions.

“Applications” → “Phone Help”

1. Press  or .

Calendar (M 7)

Calendar allows you to easily schedule appointments or events, which are associated with the date and time.

These entries can also be sent via infrared or *Bluetooth* wireless technology to a PC to share the same schedules.

Creating a New Entry

“Calendar”

1. Highlight the desired day to which you want to add an event.
2. Press [Options] and select “New Entry”.
3. Select from “Appointment”, “All Day Event” or “Anniversary”.

To Set an Appointment

1. Select the subject field and enter the subject.
2. Select the start time field and enter the desired time.
3. Select the duration.
4. Select the reminder field and select the desired option.
When selecting “Off” for the reminder option, go to step 10.
5. Select “Tone”.

6. Select “Preset Sounds” or “My Sounds”.
7. Select the desired tone.
For details on selecting a tone, see “Assigning Ringtone” on page 89.
8. Select “Vibration” and select from “On”, “Off” or “On & Link to Sound”.
For details on selecting a vibration, see “Vibration” on page 89.
9. Select “Duration” and enter the desired time.
10. Select the location field and enter the location.
11. Press [Save].

Note

- *The reminder functions even if the phone is switched off.*
- *The reminder will not sound when “Ringer Volume” (p. 88) is set to “Silent”.*

To Set an All Day Event

1. Select the subject field and enter the subject.
2. Select the date field and select the desired date.
3. Select the location field and enter the location.
4. Press [Save].

To Set an Anniversary

1. Select the anniversary option from “Ann by date” or “Ann by day”.
Select the subject field and enter the subject.
Select the date field and select the desired date (month and day).
Select the location field and enter the location.
(For “Ann by day”)
Select the subject field and enter the subject.
Select the day field and select the desired day (day of the week, week number and month).
Select the location field and enter the location.
3. Press [Save].

Sending a Schedule Entry

“Calendar”

1. Select the day including schedule entries you wish to send.
2. Press [Options] and select “Send”.
3. Select “Via Bluetooth” or “Via Infrared”.

For “Via Bluetooth”

The phone starts searching for *Bluetooth* wireless technology enabled devices within 10 metres.

When detected, a list of enabled devices is displayed allowing you to select the desired device. The connection can be established and the entry sent.

For “Via Infrared”

The phone starts searching for an infrared-enabled device within 20 centimetres.

When detected, the infrared connection is established and the entry is sent.

Note

- *When pairing, you need to enter your passcode when establishing contact with a Bluetooth wireless technology enabled device for the first time.*

Receiving a Schedule Entry

When the phone receives a schedule entry, a confirmation message is displayed in the stand-by mode screen.

1. Press [Yes].

The received entry is registered in the Calendar. Press [No] to reject.

Tip

- For details on making Infrared or Bluetooth wireless settings, see “Connectivity” on page 85.

Viewing an Entry

“Calendar”

1. Select the day you wish to view.
The daily view is displayed.

To Search By Date

1. In the monthly or daily view, press [Options].
2. Select “Go to”.
3. Select “Today” to display today or “Enter date” to enter the desired date.

To Search By Subject

1. In the monthly or daily view, press [Options].
2. Select “Find”.

3. Enter the desired text.

To Change the Week Format

1. In the monthly view, press [Options].
2. Select “Week Format”.
3. Select “Monday-Sunday” or “Sunday-Saturday”.

Deleting Entries

1. In the monthly or daily view, press [Options].
2. Select “Delete”.
3. Select the desired option.
 - “This Appointment” (daily view only):
Deletes the selected appointment.
 - “All this Day”:
Deletes all entries for the selected day.
 - “All this Month”:
Deletes all entries for the selected month.
 - “Up to Last Month”:
Deletes all entries before this month.
 - “All Schedules”:
Deletes all entries in this application.

Contacts (M 8)

Call Log (M 8-3)

The phone will record the last 10 missed calls, received calls and dialled numbers.

Viewing Call Log

“Contacts” → *“Call Log”*

1. Select the category from “All Calls”, “Dialled Nos.”, “Missed Calls” or “Received Calls”.
The selected call log list is displayed.
2. Select the phone number you wish to view.
If you wish to dial the number, press .

Tip

- You can also confirm call logs by pressing  during stand-by mode.

Sending Messages

1. In call log list, highlight the call log you wish to send a message to.
2. Press [Options] and select “Create Message”.
3. Select “Multimedia”, “Text” or “Postcard”.
For details on creating a message, see “Creating a New MMS” on page 44 or “Creating and Sending a New SMS” on page 50.

Note

- *The Postcard service is not available on some service providers. Please contact your service provider for more information.*

Deleting a Call Log

1. In call log list, press [Options] and select “Delete”.

Speed Dial List (M 8-4)

You can view and perform other operations for phone numbers registered in the Speed Dial List.

“Contacts” → **“Speed Dial List”**

The names and phone numbers stored in the Speed Dial List are displayed in order.

My Numbers (M 8-5)

You can check your own voice, data and fax phone numbers.

“Contacts” → **“My Numbers”**

1. Select the phone number you wish to check from “Voice”, “Data” or “Fax”.

Note

- “Data” or “Fax” may not be displayed depending on the SIM card.

Call Timers (M 8-6)

This function lets you check the duration of your calls.

Checking the Duration of the Last Call and All Calls

“Contacts” → **“Call Timers”**

1. Select “Received Calls” or “Dialled Nos.”.
The duration of the last call and all calls are displayed.

Data Counter (M 8-7)

You can confirm the amount of bytes that you used in the GPRS transmission.

“Contacts” → **“Data Counter”**

1. Select from “Last Data” or “All Data”.

Resetting All Data Counter

“Contacts” → **“Data Counter”** → **“Clear Counter”**

Call Costs (M 8-8)

This function lets you check the charges for your calls.

Some networks do not support Charging Advice.

Please check with your service provider for availability.

Checking the Cost of the Last Call

“Contacts” → “Call Costs” → “Last Call”

The cost of the last call is displayed.

Checking the Total Call Cost

“Contacts” → “Call Costs” → “All Calls”

The cost of all calls is displayed.

Setting the Charge Rate

Set the charge rate to calculate the call cost and set the maximum limit for call cost.

“Contacts” → “Call Costs” → “Costs Units” → “Set Units”

1. Enter your PIN2 code.
2. Enter a cost per unit.

To enter a decimal point, press ⌘ .

3. Enter a currency unit (up to 3 characters).

Setting the Charge Limit

This function is useful if you wish to make sure you do not exceed a certain charge limit.

“Contacts” → “Call Costs” → “Max Cost” → “Set Limit”

1. Enter your PIN2 code.
2. Enter a value.

To enter a decimal point, press ⌘ .

Resetting All Call Costs

“Contacts” → “Call Costs” → “Clear Costs”

1. Enter your PIN2 code.

Checking the Residual Credit

“Contacts” → “Call Costs” → “Residual Credit”

Settings (M 9)

Connectivity (M 9-1)

By configuring the settings in this menu, you can connect to *Bluetooth* wireless technology or infrared enabled phones via these connections, as well as a PC via *Bluetooth* wireless technology, infrared or USB connections.

Using the Bluetooth Wireless Function (M 9-1-1)

To Turn On or Off

“Settings” → “Connectivity” → “Bluetooth” → “Switch On/Off”

1. Select “On” or “Off”.

If the infrared setting has been activated, you will be asked whether you wish to deactivate it or not. Press [Yes].

The *Bluetooth* wireless setting is activated, and “” is displayed.

To Search for Devices to be Paired

For using the *Bluetooth* wireless function, you need to search for other *Bluetooth* wireless technology enabled devices to establish contact with your phone. Keep your phone within a distance of 10 metres before searching.

“Settings” → “Connectivity” → “Bluetooth” → “Search for Devices”

The phone starts searching for devices within 10 metres.

1. Select the desired device for pairing.
2. Enter the device passcode.

Note

- *If the Bluetooth wireless function is off before searching, the phone turns the Bluetooth wireless function on automatically and starts searching.*
- *If the infrared function is active, the confirmation screen to deactivate the infrared function is displayed. Press [Yes] to deactivate.*
- *You can only select one device for pairing. To change the paired device, see “Handsfree Devices” on page 86.*

Handsfree Devices

You can activate, rename, and delete the paired handsfree device in the list.

To Activate a Device

“Settings” → **“Connectivity”** → **“Bluetooth”** → **“Handsfree Devices”**

1. Select the device you wish to activate.

Tip

- *You can save battery power by turning the Bluetooth wireless function off whilst it is not in use. Turn the Bluetooth wireless function off in “To Turn On or Off” on page 85 or in “To Turn Off Automatically” on page 87.*
- *During a call, you can divert voice call to the paired device. Press [Options] and select “Enable Bluetooth”. If you wish to disconnect the paired device, select “Disable Bluetooth”.*

To Rename a Device

“Settings” → **“Connectivity”** → **“Bluetooth”** → **“Handsfree Devices”**

1. Highlight the device you wish to rename.
2. Press [Options] and select “Change Name”.
3. Rename the device.

To Clear a Device Name

“Settings” → **“Connectivity”** → **“Bluetooth”** → **“Handsfree Devices”**

1. Highlight the device you wish to clear.
2. Press [Options] and select “Delete”.

Paired Devices

You can rename and delete the paired device in the list.

Bluetooth Wireless Settings

With this setting you can rename your phone, prevent other GX15 phones from recognising your phone, turn the *Bluetooth* wireless function off automatically to save battery power, etc.

To Rename Your Phone

You can rename your phone. The name is shown in other devices when your phone is detected.

“Settings” → **“Connectivity”** → **“Bluetooth”** → **“Bluetooth Settings”** → **“Device Name”**

1. Enter the new device name.

To Show or Hide Your Phone

“Settings” → **“Connectivity”** → **“Bluetooth”** → **“Bluetooth Settings”** → **“Visibility”**

1. Select the desired visibility settings.

“Show My Phone”: Allows other devices to recognize your phone.

“Hide My Phone”: Hides your phone from other devices.

To Turn Off Automatically

“Settings” → **“Connectivity”** → **“Bluetooth”** → **“Bluetooth Settings”** → **“Bluetooth Time Out”**

1. Select the desired time.

Your phone turns the function off automatically in the specified time.

Using the Infrared Function (M 9-1-2)

“Settings” → **“Connectivity”** → **“Infrared”**

1. Select “On” or “Off”.

If the *Bluetooth* wireless function has been activated, you will be asked whether you wish to deactivate it or not. Press [Yes].

“” will appear on the screen.

The infrared setting will return to off when no data is transmitted/received via infrared communication.

PC Software (M 9-1-3)

By connecting your phone to a PC, you can transmit pictures, sounds, video clips, and Contacts List entries. Follow the procedure to select the connection method (*Bluetooth* wireless, USB or Infrared connection). For details on getting the link software, see page 107.

“Settings” → **“Connectivity”** → **“PC Software”**

1. Select the desired connection type from “Data Cable”, “Infrared” or “Bluetooth”.

Profiles (M 9-2)

Tone sound and vibration set can be customised for each profile according to your environment.

There are 6 profiles including one user definable profile: Normal, Meeting, Activity, Car, Headset and Silent.

Activating a Profile

“Settings” → “Profiles”

1. Select the desired profile.

Note

- When a profile is set, the corresponding icon described on page 15 is displayed on the stand-by screen.

Tip

- Press and hold  to switch Profiles settings between Normal and Silent mode during stand-by.

Customising Profiles

“Settings” → “Profiles”

1. Highlight the profile you wish to customise.
2. Press [Options] and select “Personalise”.

3. Select the setting you wish to customise and change as desired.

For details about settings, pages 88 to 92.

4. Press [Save] when finished.

Resetting Profile Settings

“Settings” → “Profiles”

1. Highlight the profile you wish to reset.
2. Press [Options] and select “Set to Default”.
3. Enter your handset code.

The default handset code is “0000”. For details on changing the handset code, see “To Change Handset Code” on page 105.

Ringer Volume





You can adjust the ringer volume to one of 6 levels or a step tone.



“Settings” → “Profiles”



1. Highlight the profile you wish to customise.
2. Press [Options] and select “Personalise”.

3. Select “Ringer Volume”.

The current volume level is displayed.

4. Press  (or ) to increase the ringer volume or press  (or ) to decrease the ringer volume and then press .



To select “Step Tone”, press  (or ) at level 5.

To select “Silent”, press  (or ) at level 1.

Assigning Ringtone

You can select the ringtone from 28 tones including 5 patterns, 13 sound effects and 10 melodies. You can also select a sound in Saved Sounds as the default ringtone excluding the AMR or WAVE format.

“Settings” → “Profiles”

1. Highlight the profile you wish to customise.
2. Press [Options] and select “Personalise”.
3. Select “Assign Ringtone”.
4. Select “Preset Sounds” or “My Sounds”.
5. Select the ringtone you wish to use.
To hear the demo play, press . To stop playing, press  again.
6. Press [Options] and select “Assign”.

Note

- If you delete a ringtone that uses a sound in Saved Sounds, the default ringtone is set.

Vibration

When the vibrator option is set on, the phone will vibrate for incoming calls regardless of the ringer volume and tone settings.

“Settings” → “Profiles”

1. Highlight the profile you wish to customise.
2. Press [Options] and select “Personalise”.
3. Select “Vibration”.
4. Select from “On”, “Off” or “On & Link to Sound”.

Tip

- When the “On & Link to Sound” option is selected in step 4, the vibrator synchronises with your selected melody to pulse in time with the melody. Please note that not all melodies support the “On & Link to Sound” option. Should you select such a melody, only the “On” option in step 4 will allow vibrator function.
- When you select “On” or “On & Link to Sound” in step 4,  is displayed on the stand-by screen.

Alerts

You can personalise profiles for alerts including warning tone, message alert and low battery alert.

Warning Tone

Your phone emits the warning tone when an error occurs.

“Settings” → “Profiles”

1. Highlight the profile you wish to customise.
2. Press [Options] and select “Personalise”.
3. Select “Alerts”.
4. Select “Warning Tone”.
5. Select “Switch On/Off”.
6. Select “On” or “Off”.
7. Select “Volume” and select from “High”, “Middle” or “Low”.
8. Select “Tone” and select “Preset Sounds” or “My Sounds”.
9. Select the desired tone.

For details on selecting a tone, see “Assigning Ringtone” on page 89.

10. Select “Duration” and select the desired time.

Message Alert

When receiving messages, special ringtones can be set.

“Settings” → “Profiles”

1. Highlight the profile you wish to customise.
2. Press [Options] and select “Personalise”.
3. Select “Alerts”.
4. Select “Message Alert”.
5. Select from “Multimedia”, “Text” or “WAP”.
6. Select “Volume” and select the desired volume.
7. Select “Sound” and select “Preset Sounds” or “My Sounds”.
8. Select the desired ringtone.
For details on selecting a ringtone, see “Assigning Ringtone” on page 89.
9. Select “Vibration” and select from “On”, “Off” or “On & Link to Sound”.
For details on selecting a vibration, see “Vibration” on page 89.
10. Select “Duration” and enter the desired time.

Low Battery Alert

Adjust the volume of the alert when the battery becomes low.

“Settings” → *“Profiles”*

1. Highlight the profile you wish to customise.
2. Press [Options] and select “Personalise”.
3. Select “Alerts”.
4. Select “Low Battery Alert”.
5. Select from “High”, “Low” or “Silent”.

Keypad Tones

When the keypad tone is set on, you will hear a confirmation tone each time you press any keys.

“Settings” → *“Profiles”*

1. Highlight the profile you wish to customise.
2. Press [Options] and select “Personalise”.
3. Select “Keypad Tones”.
4. Select “Switch On/Off”.
5. Select “On” or “Off”.
6. Select “Volume” and select from “High”, “Middle” or “Low”.

7. Select “Tone” and select from “Preset Sounds”, “My Sounds” or “Default Tone”.







When selecting “Default Tone”, go to step 9.

8. Select the desired tone.
For details on selecting the tone, see “Assigning Ringtone” on page 89.
9. Select “Duration” and select the desired time.

Multimedia Volume

You can adjust volume for Video Camera, Voice Recorder, Melody Editor, My Items, browser and multimedia messages.

“Settings” → *“Profiles”*

1. Highlight the profile you wish to customise.
2. Press [Options] and select “Personalise”.
3. Select “Multimedia Volume”.
The current volume level is displayed.
4. Press  (or ) to increase the volume or press  (or ) to decrease the volume and then press .
To select “Silent”, press  (or ) at level 1.

Power On Sound / Power Off Sound

The phone can be set to emit a sound when it is switched on or off. You can define the volume, duration and the melody to be used for this task.

“Settings” → “Profiles”

1. Highlight the profile you wish to customise.
2. Press [Options] and select “Personalise”.
3. Select “Power On Sound” or “Power Off Sound”.
4. Select “Switch On/Off”.
5. Select “On” or “Off”.
6. Select “Volume” and select the desired volume.
7. Select “Sound” and select “Preset Sounds” or “My Sounds”.
8. Select the desired sound.
For details on selecting a sound, see “Assigning Ringtone” on page 89.
9. Select “Duration” and enter the desired time.

Echo Reduction

This function is for reducing irritating echoes, especially when using the handsfree car kit.

“Settings” → “Profiles”

1. Highlight the profile you wish to customise.
2. Press [Options] and select “Personalise”.
3. Select “Echo Reduction”.
4. Select “On” or “Off”.

Any Key Answer

You can also answer a call by pressing any key except  or [Busy]. For details, see page 19.

“Settings” → “Profiles”

1. Highlight the profile you wish to customise.
2. Press [Options] and select “Personalise”.
3. Select “Any Key Answer”.
4. Select “On” or “Off”.

Auto Answer (for handsfree car kit only)

Auto Answer function allows you to answer calls automatically by connecting the handsfree car kit for Bluetooth to your phone via *Bluetooth* wireless technology.

You can select the desired time until your phone answers.

“Settings” → **“Profiles”**

1. Highlight the profile you wish to customise.
2. Press [Options] and select “Personalise”.
3. Select “Auto Answer”.
4. Select the desired time.
Select “Off” to disable it.

Setting the Display (M 9-3)

You can change the settings of the screen.

Wallpaper (M 9-3-1)

For the stand-by screen, 3 pictures are provided.

Pictures taken with the digital camera or images downloaded from a WAP site can be used for wallpapers.

Setting My Pictures

“Settings” → **“Display”** → **“Wallpaper”** → **“My Pictures”**

1. Select the desired picture.
2. After displaying the picture, press .
3. Specify the area you wish to display using the navigation keys.

Note

- *Some pictures cannot be used because of their picture and data types.*

Assigning the Pictures (M 9-3-2)

Pictures can be displayed when turning the power on or off, when receiving an incoming call, or when operating the alarm.

Pictures taken by a digital camera or images downloaded from a WAP site can be used.

To Set Built-in Pictures

“Settings” → **“Display”** → **“Graphics”**

1. Select the desired situation to set the picture.
2. Select “Preset Animation” when you select “Power On” or “Power Off” in step 1.
Select “Pattern 1”, “Pattern 2” or “Pattern 3” when you select “Incoming Call” or “Alarm” in step 1.

To Set My Pictures

“Settings” → **“Display”** → **“Graphics”**

1. Select the desired situation to set the picture
2. Select “My Pictures”.
3. Select the desired picture.
4. After displaying the picture, press .
5. Specify the area you wish to display using the navigation keys.

Note

- *Some pictures cannot be used because of their picture and data types.*

Setting the Greeting Message (M 9-3-3)

You can set the message which will appear when the phone is turned on.

“Settings” → **“Display”** → **“Greeting Message”**

1. Select “Switch On/Off”.
2. Select “On” or “Off”.
3. Select “Edit Message” and enter the message.
Up to 16 characters can be stored as a message.
For details on entering characters, see “Entering Characters” on page 24.

Showing the Clock (M 9-3-4)

You can display the current date and/or time on the stand-by screen.

“Settings” → **“Display”** → **“Show Clock”**

1. Select from “Time Only”, “Date & Time” or “Off”.

Backlight (M 9-3-5)

You can turn the backlight of the screen on or off when you press the keypad or the optional cigarette lighter charger is connected to the phone.

You can change time the backlight is on for, which will help conserve battery life.

Tip

- *When you purchase this phone, Backlight is set to 15 seconds.*

To Select the Backlight Time Out

“Settings” → “Display” → “Backlight” → “Time Out”

1. Select the desired time.
Select “Off” to turn it off.

To Turn On/Off the Backlight whilst Charging with the Cigarette Lighter Charger

With this setting On, the phone’s backlight is on when the cigarette lighter charger is connected.



“Settings” → “Display” → “Backlight” → “In Car”

1. Select “On” or “Off”.

Adjusting the Brightness of the Backlight (M 9-3-6)

You can adjust the brightness of the backlight of the screen from 4 levels.

“Settings” → “Display” → “Brightness”

1. Adjust the brightness by pressing  (Light) and  (Dark) for maximum clarity.
2. Press .

Setting the Display Saving (M 9-3-7)

This phone’s screen will automatically turn off and display the clock after a given amount of time.

You can change the time before the Display Saving will go into effect, which will help conserve battery life.

Tip

- *When you purchase this phone, Display Saving is set to 2 minutes.*

“Settings” → “Display” → “Display Saving”

1. Select the desired time.

Note

- *Display Saving does not work whilst you are calling, using WAP, or using an application.*
- *To cancel the Display Saving: The display saving continues until either a key is pressed or there is an incoming alert. The first key press only cancels this function. You must press another key in order to input any numerical or text value.*

Display Setting Reset (M 9-3-8)

The display settings can be reset to their default settings.

“Settings” → “Display” → “Set to Default”

1. Enter your handset code.

The default handset code is “0000”. For details on changing the handset code, see “To Change Handset Code” on page 105.

Sound (M 9-4)

You can use this menu to check or edit the current Profiles settings.

Call Settings (M 9-5)

Set various types of functions and services.

Diverts (M 9-5-1)

This service is used to divert incoming calls to your voice mail system or to another number depending on certain conditions in which you cannot answer a call.

To Divert Calls

“Settings” → “Call Settings” → “Diverts”

1. Select one of the following options.

- “All Calls”: Diverts all voice calls without ringing.
- “When Busy”: Diverts incoming calls when you are on a call.
- “No Answer”: Diverts incoming calls if you do not answer a call within a certain period of time.
- “Not Reachable”: Diverts incoming calls when your phone is out of network service or switched off.

2. Select “On”.

3. Enter a phone number to which you wish to divert calls or search for it in the Contacts List. (p. 31)
To use a phone number in the Contacts List, press [Contacts].
4. Press .
If you select “No Answer” in step 1:
5. Select the period of time from 6 levels (05 to 30 seconds).

Note

- When a divert is set to “All Calls”, “” is displayed on the stand-by screen.

Tip

- If you select “By Service” in step 2, you can select further divert options.

To Check the Divert Status

“Settings” → “Call Settings” → “Diverts”

1. Select the divert option you wish to check.
2. Select “Status”.

You can check the status of the selected divert option.

Call Waiting (M 9-5-2)

If you wish to be able to receive another incoming call whilst you have a call in progress, you must activate the Call Waiting service.

“Settings” → “Call Settings” → “Call Waiting”

1. Select “On” or “Off”.

Note

- The Call Waiting service may not be available on all mobile phone networks. Contact your network operator for more information.

Showing Your Phone Number (M 9-5-3)

This lets you control whether to show your phone number when calling another party or not.

“Settings” → “Call Settings” → “Show Your Number”

1. Select “On” or “Off”.

Note

- Some networks do not support this service. Please check with your service provider for availability.

Restrict Calls (M 9-5-4)

This function lets you place restrictions on incoming and outgoing calls. To activate this option you will need the specified password, which is available from your service provider.

“Settings” → “Call Settings” → “Restrict Calls”

1. Select from “Outgoing Calls” or “Incoming Calls”.

- Outgoing Calls: Restricts outgoing calls.
- Incoming Calls: Restricts incoming calls.

2. Select one of the following options.

(For “Outgoing Calls”)

- Bar Foreign Calls: Restricts all outgoing international calls.
- Bar All Outgoing Calls: Restricts all outgoing calls except emergency calls.
- Only Local & Home: Restricts all outgoing international calls except to your home country.

(For “Incoming Calls”)

- Bar All Incoming Calls: Restricts all incoming calls.

- Bar if Abroad: Restricts all incoming calls when you are outside of the coverage from your registered network operator.

3. Select one of the following options.

- “All Services”: Restricts all services.
- “Voice Calls”: Restricts all voice calls.
- “Data”: Restricts all data calls.
- “Fax”: Restricts all fax calls.
- “Messages”: Restricts all messages.
- “All except msgs”: Restricts all services except messages.

4. Select “On” or “Off”.

5. Enter the network password.

To Cancel Settings

“Settings” → “Call Settings” → “Restrict Calls”

1. Select “Outgoing Calls” or “Incoming Calls”.
2. Select “Cancel All”.
3. Enter the network password.

Fixed Dialling No.

When the Fixed Dialling No. is enabled, you can only call predefined numbers.

To Enable Fixed Dialling No.

“Settings” → **“Call Settings”** → **“Restrict Calls”** → **“Fixed Dialling No.”**

1. Enter your PIN2 code.
2. Select “Switch On/Off”.
3. Select “On” or “Off”.

To Add a New Name

“Settings” → **“Call Settings”** → **“Restrict Calls”** → **“Fixed Dialling No.”**

1. Enter your PIN2 code.
2. Select “Edit Dial List”.
3. Press [Options] and select “Add New Contact”.
4. Add a name and a phone number.

For details on adding a name and a phone number, see “Add New Contact” on page 30.

5. Press [Save].

Changing the Network Password

“Settings” → **“Call Settings”** → **“Restrict Calls”** → **“Change Password”**

1. Enter the old network password.
2. Enter a new network password.
3. Enter a new network password again.

If you enter the incorrect password, you are asked to enter the password again.

4. Press .

Auto Redial (M 9-5-5)

See “Automatic Redialling” on page 19.

Minute Minder (M 9-5-6)

Minute Minder function informs you of your talk time by sounding a tone after every minute.

“Settings” → **“Call Settings”** → **“Minute Minder”**

1. Select “On” or “Off”.

Call Setting Reset (M 9-5-7)

The call settings can be reset to their default settings.

“Settings” → “Call Settings” → “Set to Default”

1. Enter your handset code.

The default handset code is “0000”. For details on changing the handset code, see “To Change Handset Code” on page 105.

Date & Time (M 9-6)

You need to set the correct time and date in order for your phone’s various time-based functions to work correctly.

“Settings” → “Date & Time” → “Set Date/Time”

1. Enter the day, month, year and time using the digit keys.

Tip

- When you enter the time in the 12-hour format, press **[*+0]** to switch between am and pm. The order in which the date and time is displayed is based on the format setting.

Selecting the Time Format

“Settings” → “Date & Time” → “Time Format”

1. Select “12 hour” or “24 hour”.

Selecting the Date Format

“Settings” → “Date & Time” → “Date Format”

1. Select from “D.M.Y”, “M-D-Y”, or “Y/M/D”.

Setting the Daylight Saving

“Settings” → “Date & Time” → “Daylight Saving”

1. Select “On” or “Off”.

Setting the Time Zone

“Settings” → “Date & Time” → “Time Zone” → “Change Zone”

1. Press **[←]** or **[→]** to select the home city to set.

Customising the Time Zone

“Settings” → “Date & Time” → “Time Zone” → “Set Custom Zone”

1. Enter the time-zone differences using the digit keys.
Pressing **[*+0]** switches between – and +.

Changing the Language (M 9-7)

You can change the language that the phone uses to display messages.

“Settings” → “Language”

1. Select the desired language.

Tip

- You can also change the input language on the text entry screen (p. 25).

Note

- If you select “Automatic” in step 1, the language preset on the SIM card is selected.
- If the language preset on the SIM card is not supported, then the default language of the phone is selected.

Network (M 9-8)

Network Settings (M 9-8-1)

To Select a Network Automatically

Each time the power is turned on, your phone always tries to connect to the preferred network.

If your phone is not connected to the network, you can perform the following immediately to establish the preferred network connection.

“Settings” → “Network” → “Select Network” → “Automatic”

To Set the Network Manually

“Settings” → “Network” → “Select Network” → “Manual”

1. Select the desired network.

To Add a New Network

“Settings” → “Network” → “Select Network” → “Add New Network”

If there is no entry, press  and go to step 2.

If there is an entry, press  and perform the following steps.

1. Select “Add”.
2. Enter the country code.
3. Enter the network code.
4. Enter a new network name.

To Change the Position of a Network in the Preferred List

“Settings” → “Network” → “Select Network” → “Set Preferred”

1. Select the name of the network to change the position in the list.
2. Select “Insert” or “Add to end”.

To Delete a Network from the Preferred List

“Settings” → “Network” → “Select Network” → “Set Preferred”

1. Select the name of the network you wish to delete.
2. Select “Delete”

WAP/MMS Settings

Note

- *In normal operations, you do not need to change settings.*

WAP Settings (*: Item to be set as mandatory)

“Profile Name”*: WAP profile name (Unique name)

“IP Address”*: IP address for WAP

“Homepage”: Homepage

“Port Number”*: Security option (1024-65535)

“Circuit Prompt”: Circuit prompt (“Enable” or “Disable”)

“Connection Type”:

Bearer connection type (“GPRS Then CSD”, “GPRS” or “CSD”)

GPRS Settings:

“APN”*: Access point name

“Username”: User name

“Password”: Password

“Linger Time”: Linger time (0-99999 sec.)

CSD Settings:

“Phone No.”*: Access point number

“Line Type”: Line type (“ISDN” or “Analogue”)

“Username”: User name

“Password”: Password

“Linger Time”: Linger time (0-99999 sec.)

MMS Settings (*: Item to be set as mandatory)

“Profile Name”*: MMS profile name (Unique name)

“IP Address”*: IP address for MMS

“Relay Server URL”*:
MMS relay server

“Port Number”*: Security option (1024-65535)

“Connection Type”: Bearer connection type (“GPRS
Then CSD”, “GPRS” or “CSD”)

GPRS Settings:

“APN”*: Access point name

“Username”: User name

“Password”: Password

“Linger Time”: Linger time (0-99999 sec.)

CSD Settings:

“Phone No.”*: Access point number

“Line Type”: Line type (“ISDN” or “Analogue”)

“Username”: User name

“Password”: Password

“Linger Time”: Linger time (0-99999 sec.)

To Activate the WAP/MMS Profile

“**Settings**” → “**Network**”

1. Select from “WAP Settings” or “MMS Settings”.
2. Select the desired profile.

To Edit the WAP/MMS Profile

“**Settings**” → “**Network**”

1. Select from “WAP Settings” or “MMS Settings”.
2. Highlight the desired profile.
3. Press [Options] and select “Edit”.
4. Edit the desired item.

To Copy the WAP/MMS Profile

“**Settings**” → “**Network**”

1. Select from “WAP Settings” or “MMS Settings”.
2. Highlight the desired profile.
3. Press [Options] and select “Copy”.
4. Edit the new profile name.

To Delete the WAP/MMS Profile

“Settings” → **“Network”**

1. Select from “WAP Settings” or “MMS Settings”.
2. Highlight the desired profile.
3. Press [Options] and select “Delete”.

Security (M 9-9)

Auto Keypad Lock (M 9-9-1)

By setting this option on, your phone will lock the keypad in 20 seconds automatically if no operation is performed.

“Settings” → **“Security”** → **“Auto Keypad Lock”**

1. Select the desired time.
Select “Off” to turn it off.

Enabling/Disabling the PIN Code (M 9-9-2)

If the PIN code is enabled you are asked to enter the PIN code each time the phone is switched on. Your PIN code is stored on the SIM card and you should have been made aware of the code when you purchased the SIM card. Contact your service provider for further details.

“Settings” → **“Security”** → **“PIN Entry”**

1. Select “On” to enable the PIN code.
Select “Off” to disable it.
2. Enter your PIN code.

Note

- *If you enter the wrong PIN code three times in step 2, the SIM card will lock. To remove the lock, contact your service provider/SIM card vendor.*

To Change PIN Code

This allows you to change the PIN code stored on the SIM card. Before you change the PIN code, select “On” in step 1 in “Enabling/Disabling the PIN Code” on page 104.

“Settings” → “Security” → “PIN Entry” → “Change PIN”

1. Enter the existing PIN code.
2. Enter a new PIN code.
3. Enter the new PIN code again.

Changing PIN2 Code (M 9-9-3)

PIN2 code is used to protect certain functions in the phone such as Fixed Dialling No. and call cost limits. The following shows you how to change PIN2 code.

“Settings” → “Security” → “Change PIN2”

1. Enter the existing PIN2 code.
2. Enter a new PIN2 code.
3. Enter the new PIN2 code again.

Handset Lock (M 9-9-4)

The Handset Lock is an additional security feature which prevents unauthorised use of the phone or certain features.

“Settings” → “Security” → “Handset Lock”

1. Select “On” or “Off”.
2. Enter your handset code.

To Change Handset Code

Before you change the handset code, select “On” in step 1 in “Handset Lock”. The default handset code is “0000”.

“Settings” → “Security” → “Handset Lock” → “Change code”

1. Enter the old handset code.
2. Enter a new handset code.
3. Enter the new handset code again.

Master Reset (M 9-0)

All settings can be reset to their default settings.

“Settings” → “Master Reset”

1. Enter your handset code.

Connecting GX15 to Your PC

You can use the following functions by connecting the GX15 to your PC using an infrared port, USB port* or *Bluetooth* wireless technology port:

- GSM/GPRS modem
- Handset Manager for GX15
- * Requires an optional USB data cable XN-1DC30 for USB port connection.

System Requirements

Operating System:

Windows[®] 98*, Windows[®] Me, Windows[®] 2000**, Windows[®] XP***

- * Windows[®] 98 Second Edition, Windows[®] 98 Service Pack 1 with Internet Explorer 5.01 or later
- ** Service Pack 4
- ***Service Pack 1a

Supported Software:

Microsoft[®] Outlook/Outlook Express

Interface:

Infrared port, USB port or *Bluetooth* wireless port
CD-ROM drive

GSM/GPRS Modem

You can use GX15 as a GSM/GPRS modem to access the Internet from your PC. Connect your phone to your PC via *Bluetooth* wireless technology, infrared or USB interface. Software installation on your PC is required. For details, see “Software Installation” on page 107.

Modem via the Infrared Connection

To use the modem function via the Infrared connection, see “Using the Infrared Function” on page 87 and turn the modem function on.

Modem via the USB Cable

To use the modem function using a USB cable, use the cable mentioned above and see the instructions accompanying the cable.

Modem via Bluetooth connection

To use the modem function via *Bluetooth* wireless technology interface, see “Using the Bluetooth Wireless Function” on page 85 and turn the modem function on.

For details on software support, refer to the following site:

<http://www.sharp-mobile.com>

Note

- *Modem communication is not possible whilst communicating with the Handset Manager via Bluetooth wireless technology, infrared or USB interface.*

Handset Manager

You can transmit the following items between your phone and your PC, and can use Contacts List entries on your PC.

- My Items files (pictures/sounds/video clips)
- Contacts List entries
- Short messages
- Schedule entries
(You can send Microsoft Outlook schedule entries to your phone.)

To use the Handset Manager function, see “PC Software” on page 87 and set your phone to Data Transfer mode.

For details on software support, refer to the following site:

<http://www.sharp-mobile.com>

Software Installation

1. Insert the supplied CD-ROM into your CD-ROM drive.
The GX15 CD-ROM screen is displayed.
If the GX15 CD-ROM screen is not displayed, double-click [Launcher.exe] in your CD-ROM.
2. Press the desired button.
The installation starts.
3. Follow the on-screen instructions to complete installation.

Note

- *The phone may not recognize the USB data cable if it is connected whilst an application (Camera, My Items, etc.) is running. Connect the USB data cable during stand-by.*

Infrared communication

- *Infrared ports need to be aligned with each other.*

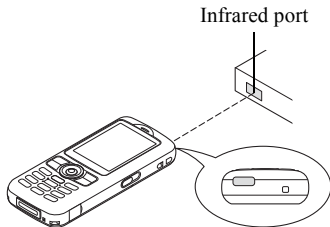

- *Infrared ports need to be placed within 20 cm of each other and within a 30° angle.*

GSM/GPRS modem

- *It is not recommended that you make or answer calls when you are using GX15 as a GSM/GPRS modem. The operation may be interrupted.*

Handset Manager

- *Some large files may not be able to be transmitted from the PC to the phone.*
- *When connecting your phone to a PC, you need to select the connection method for PC Software. (p. 87)*

- *Applications (Camera, My Items, etc.) do not run when the phone is connected to the PC via Bluetooth wireless technology interface, infrared port or USB data cable.*

Troubleshooting

Problem	Solution
The phone does not turn on.	<ul style="list-style-type: none"> • Make sure the battery is properly inserted and charged.
PIN code or PIN2 code is rejected.	<ul style="list-style-type: none"> • Make sure you have entered the correct code (4 to 8 digits). • Your SIM card/protected functions will become locked after 3 unsuccessful attempts. • Contact your SIM provider if you do not have the correct PIN code.
The SIM card becomes locked.	<ul style="list-style-type: none"> • Enter PUK code (8 digits) provided by your service provider (if supported). • If the attempt is successful, enter the new PIN code and confirm your phone is operational again. Otherwise contact your dealer.
The display is difficult to read.	<ul style="list-style-type: none"> • Adjust the backlight brightness for the display.

Problem	Solution
Phone functions do not work after the phone is turned on.	<ul style="list-style-type: none"> • Check the radio signal strength indicator as you may be outside the service area. • Check to see if any error message is displayed when you turn your phone on. If so, contact your dealer. • Make sure the SIM card is correctly inserted.
Calls cannot be made or received.	<ul style="list-style-type: none"> • If the message “SIM card error” is displayed at start-up, you cannot use your SIM card or the SIM card is damaged. Contact your dealer or network service provider. • Check your call barring, fixed dialling setting, remaining battery and call forwarding settings. • Check if your phone is currently performing data communication using Infrared (IrDA), <i>Bluetooth</i> wireless technology interface or a USB data cable. • Check the remaining balance if you are using a pre-paid SIM card.

Problem	Solution
Call quality is poor.	<ul style="list-style-type: none"> Your current location may not provide good call quality (i.e., in a car or train). Move to a location where radio signal strength is greater.
Cannot access network service.	<ul style="list-style-type: none"> Check where your account has been registered and where the service is available.
Cannot send or receive Text Message.	<ul style="list-style-type: none"> Make sure you are correctly subscribed for the Short Message Service, that the network supports this service, and that the centre number is set up correctly. If not, contact your network service provider.
Cannot connect to Multimedia Message service provider.	<ul style="list-style-type: none"> MMS settings and configuration may be missing or incorrect or the network does not support it. Check your service provider's access point number. Contact your service provider to confirm the correct settings.

Problem	Solution
Limited memory available.	<ul style="list-style-type: none"> Delete any unnecessary data.
Call is terminated unexpectedly.	<ul style="list-style-type: none"> Magnetised objects such as health necklaces placed near the phone may terminate the call. Keep your phone away from such objects.
No entries are displayed in the Contacts List	<ul style="list-style-type: none"> Confirm that the Contacts Location setting (Handset or SIM) and View Groups setting are made correctly.
Fax transmission failure	<ul style="list-style-type: none"> Before transmitting fax data, configure your fax software to use the software flow control. Use of the optional data cable is recommended for transmitting fax data.
Cannot receive OBEX data.	<ul style="list-style-type: none"> The OBEX data can only be received only during stand-by. The message "Please return to stand-by." is displayed.

Safety Precautions and Conditions of Use

Your phone conforms to international regulations insofar as it is used under normal conditions and in accordance with the following instructions.

CONDITIONS OF USE

Electromagnetic waves

- Do not switch on your phone aboard an aircraft (as your phone may interfere with the aircraft's electronic systems). Current legislation forbids this use and legal action can be taken against the user.
- Do not switch on your phone in a hospital, except in designated areas.
- Use of your phone's function may affect the performance of medical electronic units (pacemakers, hearing aids, insulin pumps, etc.). When the phone function is on, do not bring it near medical equipment or into areas in which medical equipment is being used. If you have a hearing aid or a pacemaker, only use the phone on the opposite side of your body from where it is located. The phone should be kept at least 6 inches (15.24 cm) from a pacemaker ANYTIME the phone is switched on.

- Do not switch on your phone near gas or flammable substances.
- Observe the rules concerning the use of mobile phones at gasoline stations, chemical plants and at all sites where a risk of explosion exists.

Caring for your phone

- Do not allow children to use your phone without supervision.
- Do not open or attempt to repair your phone yourself. The product can only be repaired by authorised service personnel.
- Do not drop your phone or subject it to severe impacts. Bending the body and pushing the display or keys with extreme force could damage the phone.
- Do not use solvents to clean your phone. Use only a soft, dry cloth.
- Do not carry your phone in your back pocket as it could break when you sit down. The display is made of glass and is particularly fragile.
- Avoid touching the external connector on the underside of the phone, since the delicate components within can be damaged by static electricity.

Battery

- Use your phone only with batteries, chargers and accessories recommended by the manufacturer. The manufacturer disclaims any liability for damage caused by the use of other chargers, batteries or accessories.
- **Network configuration and phone usage will affect talk-time and stand-by time.**
Using the games or camera will hasten battery consumption.
- **When the battery charging alert is displayed on the screen, charge the battery as soon as possible.** If you continue using your phone ignoring the alert, the phone may cease to function, and all data and settings you have stored may be lost at any moment.
- Before removing the battery from the phone, make sure the phone is switched off.
- Replace and charge the new battery as soon as possible after removing the old one.
- Do not touch the battery terminals. Batteries can cause damage, injury or burns if a conductive material touches exposed terminals. When the battery is detached from the phone, use a cover made of non-conductive material for keeping and carrying the battery safely.

- Recommended temperature for using and storing batteries is approximately 20°C.
- The batteries' performance is limited in low temperatures, particularly below 0°C and the phone may not work temporarily regardless of the amount of remaining battery power.
- Exposing the phone to extreme temperatures will shorten battery life.
- The battery can be charged and discharged hundreds of times but it will eventually wear out. When the operating time (talk-time and stand-by time) is noticeably shorter than normal, it is time to buy a new battery.

CAUTION

**RISK OF EXPLOSION IF BATTERY IS REPLACED
BY AN INCORRECT TYPE,
DISPOSE OF USED BATTERIES ACCORDING
TO THE INSTRUCTIONS**

See “Battery Disposal” on page 11.

Aerial Care

- Do not cover the top of the phone (p. 8, No. 19) with your hand when in use as this may interfere with the performance of the built-in aerial. Call quality may deteriorate leading to shortened talk-time and stand-by time because the mobile phone has to operate on a higher power level than is necessary.
- Use only the aerial supplied or one approved by Sharp for your mobile phone. Using unauthorised or modified aerials may damage the mobile phone. Moreover, since the mobile phone may violate the appropriate regulations, it may lose performance or exceed the limitation of SAR levels.
- To avoid impaired performance, do not damage the aerial of the mobile phone.
- Whilst talking directly to the microphone, please hold the mobile phone so that the aerial is upwards over your shoulder.
- To avoid interfering with blasting operations, please turn off the mobile phone in a blasting area or in a place where a “turn off two-way radio” sign is posted.

Camera Operation

- Learn picture quality, file formats, etc. beforehand. The taken pictures can be saved in JPEG format.

- Be careful not to move your hand whilst taking pictures.
If the phone moves whilst taking a picture, the picture can be blurred. When taking a picture, hold the phone firmly to prevent it from moving, or use the delay timer.
- Clean the lens cover before taking a picture. Fingerprints, oils, etc. on the lens cover hinder clear focusing. Wipe them off with a soft cloth before taking a picture.

Others

- As with any electronic storage unit, data may be lost or corrupted under various circumstances.
- Before connecting the phone with a PC or a peripheral unit, read the operation manual for the other unit carefully.
- If the phone’s battery has been removed for some time, or the phone has been reset, the unit’s clock and calendar may be reinitialised. The date and time should be updated in this case.
- Use only the specified personal handsfree kit (option). Some phone’s functions may not work when unauthorised handsfree kit is used.

ENVIRONMENT

- Keep your phone away from extreme heat. Do not leave it on the dashboard of a car or near a heater. Do not leave it in any place that is extremely damp or dusty.
- Since this product is not waterproof, do not use it or store it where fluids such as water can splash onto it. Raindrops, water spray, juice, coffee, steam, perspiration, etc. will also cause a malfunction.

PRECAUTIONS CONCERNING VEHICLE USE

- It is the user's responsibility to check the local laws governing the use of a mobile phone in vehicles. Pay full attention to driving. Pull off to the side of the road, park the car, and switch off the engine before making or answering a call.
- Use of your phone's function may interfere with the vehicle's electronic systems, such as the ABS anti-lock brakes or the air-bag. To ensure no such problem occurs, please check with your dealer or car manufacturer before connecting your phone.
- Only allow qualified service maintenance personnel to install the vehicle accessories.

The manufacturer disclaims any liability for damage which may result as a consequence of improper use or use contrary to the instructions contained herein.

SAR

Your Sharp mobile phone has been designed, manufactured and tested so as not to exceed the limits for exposure to electromagnetic fields recommended by the Council of the European Union. These limits are part of comprehensive guidelines developed by independent scientific organisations. The guidelines include a substantial safety margin designed to assure the safety of the phone user and others and to take into account variations in age and health, individual sensitivities and environmental conditions. European standards provide for the amount of radio frequency electromagnetic energy absorbed by the body when using a mobile phone to be measured by reference to the Specific Absorption Rate (SAR). The SAR limit for the general public is currently 2 watts per kilogram averaged over 10 grams of body tissue. Your Sharp mobile phone SAR value is 0.835 watts per kilogram. This has been tested to ensure that this limit is not exceeded even when the phone is operating at its highest certified power. In use however your Sharp mobile phone may operate at less than full power because it is designed to use only sufficient power to communicate with the network.

PRECAUTIONS FOR USE IN USA

FCC Declaration of Conformity

This mobile phone GX15 with PC/Data interface cable XN-1DC30 complies with part 15 of the FCC Rules.

Operation is subject to the following two conditions:

- (1) This device may not cause harmful interference, and
- (2) this device must accept any interference received, including interference that may cause undesired operation.

Responsible Party:

SHARP ELECTRONICS CORPORATION

Sharp Plaza, Mahwah, New Jersey 07430

TEL: 1-800-BE-SHARP

Tested To Comply With FCC Standards

FOR HOME OR OFFICE USE



FCC Notice

The phone may cause TV or radio interference if used in close proximity to receiving equipment. The FCC can require you to stop using the phone if such interference cannot be eliminated.

Information To User

This equipment has been tested and found to comply with the limits of a Class B digital device, pursuant to Part 15 of the FCC Rules. These limits are designed to provide reasonable protection against harmful interference in a residential installation. This equipment generates, uses and can radiate radio frequency energy and, if not installed and used in accordance with the instructions, may cause harmful interference to radio communications.

However, there is no guarantee that interference will not occur in a particular installation; if this equipment does cause harmful interference to radio or television reception, which can be determined by turning the equipment off and on, the user is encouraged to try to correct the interference by one or more of the following measures:

1. Reorient/Relocate the receiving antenna.
2. Increase the separation between the equipment and receiver.
3. Connect the equipment into an outlet on a circuit different from that to which the receiver is connected.
4. Consult the dealer or an experienced radio/TV technician for help.

CAUTION: Changes or modifications not expressly approved by the manufacturer responsible for compliance could void the user's authority to operate the equipment.

Exposure to Radio Waves

THIS MODEL PHONE MEETS THE GOVERNMENT'S REQUIREMENTS FOR EXPOSURE TO RADIO WAVES.

Your wireless phone is a radio transmitter and receiver. It is designed and manufactured not to exceed the emission limits for exposure to radio frequency (RF) energy set by the Federal Communications Commission of the U.S. Government. These limits are part of comprehensive guidelines and establish permitted levels of RF energy for the general population. The guidelines are based on standards that were developed by independent scientific organizations through periodic and thorough evaluation of scientific studies. The standards include a substantial safety margin designed to assure the safety of all persons, regardless of age and health.

The exposure standard for wireless mobile phones employs a unit of measurement known as the Specific Absorption Rate, or SAR. The SAR limit set by the FCC is 1.6W/kg.* Tests for SAR are conducted using standard operating positions specified by the FCC with

the phone transmitting at its highest certified power level in all tested frequency bands. Although the SAR is determined at the highest certified power level, the actual SAR level of the phone while operating can be well below the maximum value. This is because the phone is designed to operate at multiple power levels so as to use only the power required to reach the network. In general, the closer you are to a wireless base station antenna, the lower the power output.

Before a phone model is available for sale to the public, it must be tested and certified to the FCC that it does not exceed the limit established by the government-adopted requirement for safe exposure. The tests are performed in positions and locations (e.g., at the ear and worn on the body) as required by the FCC for each model. The highest SAR value for this model phone when tested for use at the ear is 0.352 W/kg and when worn on the body, as described in this user guide, is 0.544 W/kg. Body-worn Operation; This device was tested for typical body-worn operations with the back of the phone kept 1.5 cm from the body. To maintain compliance with FCC RF exposure requirements, use accessories that maintain a 1.5 cm separation distance between the user's body and the back of the phone. The use of belt-clips, holsters and similar accessories should not contain metallic components in its assembly.

The use of accessories that do not satisfy these requirements may not comply with FCC RF exposure requirements, and should be avoided. While there may be differences between the SAR levels of various phones and at various positions, they all meet the government requirement for safe exposure.

The FCC has granted an Equipment Authorization for this model phone with all reported SAR levels evaluated as in compliance with the FCC RF emission guidelines. SAR information on this model phone is on file with the FCC and can be found under the Display Grant section of <http://www.fcc.gov/oet/fccid> after searching on FCC ID APYHRO00035.

Additional information on Specific Absorption Rates (SAR) can be found on the Cellular Telecommunications & Internet Association (CTIA) web-site at <http://www.phonefacts.net>.

* In the United States and Canada, the SAR limit for mobile phones used by the public is 1.6 watts/kg (W/kg) averaged over one gram of tissue. The standard incorporates a substantial margin of safety to give additional protection for the public and to account for any variations in measurements.

Index

- A**
 - Accessories 7
 - Alarms 71
- B**
 - Battery 10
 - Bluetooth wireless function 85
- C**
 - Calculator 72
 - Calendar 79
 - Call Costs 84
 - Call functions 18
 - Answering 19
 - Call Waiting 21
 - Conference Call 22
 - Earpiece volume 20
 - Making 18
 - Muting 23
 - Putting on hold 21
 - Redialling 19
 - Speed dialling 18
 - Call Log 82
 - Call settings 96
 - Auto Redial 99
 - Call Waiting 97
 - Diverts 96
 - Minute Minder 99
 - Resetting 100
 - Restrict Calls 98
 - Show Your Number 97
 - Call Timers 83
 - Cell Broadcasts 52
 - Centre key 8, 15
 - Contacts List 29
 - Assigning a ringtone 33
 - Changing the list 29
 - Changing the name order 30
 - Copying 31
 - Creating 30
 - Deleting 32
 - Dialling 32
 - Editing 32
 - Finding 31
 - Group Call 33
 - Memory status 34
 - Receiving 35
 - Selecting the storage memory 29
 - Sending 34
 - Viewing groups 32
- D**
 - Data Counter 83
 - Date & Time 100
 - Digital camera 36
 - Display indicators 15
 - Display language 101
 - Display settings
 - Backlight 95
 - Brightness of backlight 95
 - Display saving 95
 - Greeting message 94
 - Resetting 96
 - Showing the clock 94
 - Wallpaper 93
- E**
 - Earpiece volume 20
 - Emergency calls 18
- H**
 - Handset code 105
 - Handset Lock 105
- I**
 - Infrared function 87
 - Infrared port 9
 - Input languages 25

Input method 25
International calls 18

J

Java™ applications 67

K

Keypad Lock 14

L

Left soft key 8

M

Master Reset 105

Melody Editor 74

Memory status 66

Menu and shortcut 27

Multimedia message 44

- Confirming arrival of delivery report 47

- Creating 44

- Inserting attached data 46

- Reading 46

- Retrieving 47

- Sending with Postcard 48

- Setting up 47

- Storing the phone number or e-mail address of a sender in the Contacts List 47

- Turning the slide show setting on or off 45

My Numbers (Voice/Data/Fax) 83

N

Navigation keys 8

Network settings 101

P

PC connection 106

PC Software 87

Phone Help 78

Picture file 58

PIN code 104

PIN2 code 105

Power on and off 13

Profiles

- Activating 88

- Alerts 90

- Any Key Answer 92

- Customising 88

- Echo reduction 92

- Keypad tones 91

- Multimedia Volume 91

- Power Off Sound 92

- Power On Sound 92

- Resetting 88

- Ringer volume 88

- Ringtone 89

- Vibration 89

R

Right soft key 9

S

Screensavers 68

Security 104

- Auto Keypad Lock 104

- Changing PIN2 code 105

- Enabling/Disabling PIN code 104

- Handset Lock 105

Self-portrait mirror 37

SIM Application 71

SIM card 10

Sound file 61

Speed Dial List 83

T

Text message 49

- Creating 50

- Extracting phone numbers 51

- Reading 50

- Setting up 51

Text template 65

Troubleshooting 109

V

- Video camera 40
- Video clip file 63
- Vodafone live! 54
- Voice mail key 9
- Voice Recorder 73