

Declaration of Conformity

Hereby, Sharp Telecommunications of Europe Ltd, declares that this GX20 is in compliance with the essential requirements and other relevant provisions of Directive 1999/5/EC.

A copy of the original declaration of conformity can be found at the following Internet address:

<http://www.sharp-mobile.com>

Introduction

Congratulations and thank you for choosing the GX20.

About This User Guide

This user guide is carefully designed to help you learn about your phone's features and operations quickly and effectively.

NOTICE

- We strongly recommend that you keep separate permanent written records of all important data. Data may be lost or altered in virtually any electronic memory product under certain circumstances. Therefore, we assume no responsibility for data lost or otherwise rendered unusable, whether as a result of improper use, repairs, defects, battery replacement, use after the specified battery life has expired or any other cause.
- We assume no responsibility, directly or indirectly, for financial losses or claims from third parties resulting from the use of this product and any of its functions, such as stolen credit card numbers, the loss or alteration of stored data, etc.
- All company and/or product names are trademarks and/or registered trademarks of their respective holders.
- Screen layout illustrated in this user guide may differ from the actual one.
The information described in this user guide is subject to change without notice.

- All the functions described in this user guide may not be supported in all networks.
- We assume no responsibility for downloaded contents, information, etc. from network.
- The CGS-LCD is a world advanced technology product, giving you fine picture quality. Occasionally, a few black or bright pixels may appear on the screen. Please note that this will not have any impact on any of the features or performance.

Copyright

According to copyright laws, the reproduction, alteration and use of material which is protected by copyright (music, pictures, etc.) is only permitted for personal or private use. If the user is not in possession of more extensive copyright or has not received the explicit permission from the copyright owner to reproduce, alter or use a copy which has been made or modified in this way, this is considered to be a violation of the copyright laws and gives the copyright owner the right to claim for damages. For this reason, avoid the illegal use of material which is protected by copyright.

Windows is a registered trademark of Microsoft Corporation in the United States and/or other countries.

Powered by JBlend[®], ©1997-2003 Aplix Corporation. All rights reserved.

Java and all Java-based trademarks and logos are trademarks or registered trademarks of Sun Microsystems, Inc. in the U.S. and other countries.

JBlend and all JBlend-based trademarks and logos are trademarks or registered trademarks of Aplix Corporation in Japan and other countries.

In this product, JBlend[®] is incorporated.

JBlend[®] is a Java execution environment that Aplix developed for implementing advanced performance and fast operation on small-memory systems. JBlend and JBlend logo are trademarks or registered trademarks of Aplix Corporation in Japan and other countries.



Powered by Mascot Capsule[®]/Micro3D Edition[™]

Mascot Capsule[®] is a registered trademark of HI Corporation

©2002-2003 HI Corporation. All Rights Reserved.

Licensed by Inter Digital Technology Corporation under one or more of the following United States Patents and/or their domestic or foreign counterparts and other patents pending, including U.S. Patents: 4,675,863; 4,779,262; 4,785,450 & 4,811,420.

Licensed under U.S. Patent 4,558,302 and foreign counterparts.

T9 Text Input is licensed under one or more of the following: U.S. Pat. Nos. 5,818,437, 5,953,541, 5,187,480, 5,945,928, and 6,011,554; Australian Pat. No. 727539; Canadian Pat. No. 1,331,057; United Kingdom Pat. No. 2238414B; Hong Kong Standard Pat. No. HK0940329; Republic of Singapore Pat. No. 51383; Euro. Pat. No. 0 842 463 (96927260.8) DE/DK, FI, FR, IT, NL,PT,ES,SE,GB; Republic of Korea Pat. Nos. KR201211B1 and KR226206B1; and additional patents are pending worldwide.

Useful Functions and Services of the Phone

Your phone offers you the following features:

- Built-in digital camera that can take pictures and record video clips.
- Create and read SMS (Text Message).
- Multimedia Messaging Service (MMS) can personalise your phone in various ways: you can send and receive multimedia messages with graphical images, photographs, sound or video clips attached.
- WAP browser to help you access a variety of information on the mobile Internet.
- Java™ applications. You can also download various kinds of applications from Vodafone live! via the mobile Internet.
- Continuous grain silicon (CGS) colour LCD main display with images that are clearer and easier to view.
- Colour external display enables you to quickly see who is calling and if you have any new messages.
- Mobile light with large number of uses: as a camera flash, battery charge notification, incoming call indicator and a makeshift torch.
- Melody editing function allows you to create original ringtones using up to 16 voices.
- Voice memo function allows you to record and play back your voice messages.

Table of Contents

Introduction	1	Entering Characters	29
Useful Functions and Services of the Phone	3	Changing the Input Languages	30
Table of Contents	4	Changing the Input Method	30
Your Phone	7	Using Text Templates	31
Optional Accessories	7	Using the Menu	32
Getting Started	8	List of Menu Functions	34
Inserting the SIM Card and the Battery	11	Contacts List	35
Charging the Battery	14	Selecting the Contacts List Memory	35
Turning Your Phone On and Off	16	Creating a New Entry	36
Display Indicators (Main Display)	17	Finding a Name and Number	40
Display Indicators (External Display)	19	Dialling Using Contacts List Entries	40
Call Functions	21	Editing Contacts List Entries	41
Making a Call	21	Deleting a Single Contacts List Entry	42
Speed Dialling	21	Deleting All Contacts List Entries	42
Redialling	22	Viewing Groups	42
Ending a Call	22	Memory Status	44
Answering a Call	23	Speed Dial List	45
Incall Menus	24	Sending Messages	45
		Swapping Location Number of the Phone Number	46

Camera	47	Applications	114
Digital Camera	47	SIM Application	114
Video Camera	54	Calendar	114
Messages	59	Alarm	116
Multimedia (MMS)	59	Calculator	119
Text (SMS)	70	Voice Memo	121
Cell Broadcasts	76	PC Link	122
Area Info	78	Phone Help	122
Vodafone live!	79	Profiles	123
Viewing the WAP Browser	79	Activating a Profile	123
Navigating a WAP Page	80	Customising Profiles	124
My Stuff	83	Resetting Profile Settings	124
Games & More	83	Ringer Volume	125
Pictures	86	Assigning Melody	125
Sounds	92	Vibration	126
Video Clips	95	Keypad Tones	126
Bookmarks	97	Warning Tone	127
Text Templates	98	Power On/Off Sound	128
Memory Status	99	Message Alert	128
Fun & Games	100	Low Battery Alert	129
Games & More	100	Any Key Answer	129
Melody Editor	105	Contacts	130
		Call Log	130

Call Timers	131	Troubleshooting	169
Call Costs	132	Safety Precautions and	
Data Counter	134	Conditions of Use	171
Speed Dial List	135	CONDITIONS OF USE	171
My Numbers	135	ENVIRONMENT	174
Settings	136	PRECAUTIONS CONCERNING	
Phone Settings	136	VEHICLE USE	174
Call Settings	145	Index	176
Diverts	148		
Date & Time	150		
Network Settings	152		
Internet Settings	154		
Infrared	160		
Security	160		
Master Reset	166		
Connecting GX20 to Your PC	167		
System Requirements	167		
GSM/GPRS Modem	167		
Handset Manager	167		
Software Installation	167		
Note	168		

Your Phone

Please check the following carefully. Your phone should come complete with:

- GSM 900/1800/1900 GPRS phone
- Rechargeable Li-ion battery
- AC charger
- Hands free
- CD-ROM
- User guide

Optional Accessories

- Li-ion spare battery (XN-1BT11)
- High capacity Li-ion battery (XN-1BT13)
- Cigarette lighter charger (XN-1CL10)
- Data cable (RS232C cable: XN-1DC10)
- AC charger (XN-1QC11)

The above accessories may not be available in all regions.

For details, please contact your dealer.



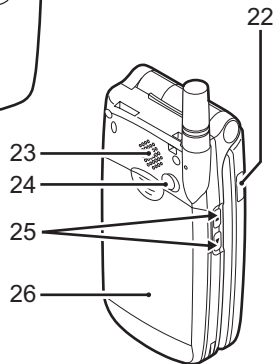
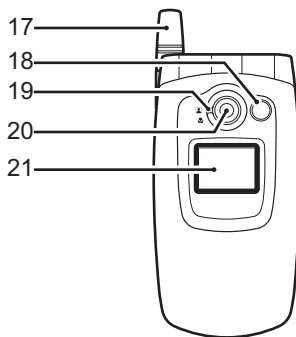
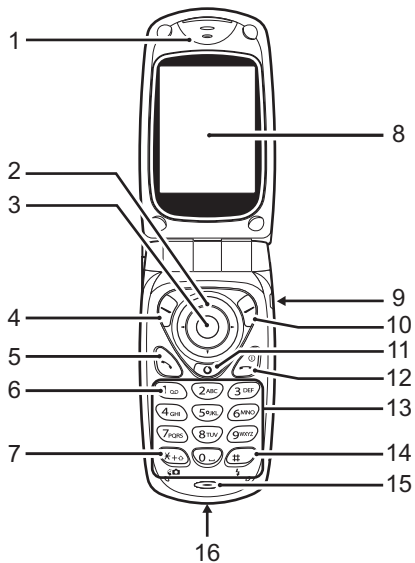

Getting Started



1. Earpiece

2. Navigation Keys (Arrow Keys):

Moves cursor to select menu items, etc.

, , ,  in this manual indicate these keys.

Up/Down arrow keys: Displays Contacts List entries in stand-by mode.

Left arrow key: Displays list of Applications in stand-by mode.

Right arrow key: Displays list of Saved Pictures in stand-by mode.

3. Centre Key:

Displays Main menu in stand-by mode and executes functions.
 in this manual indicates this key.

4. Left Soft Key:

Executes the function at the bottom left of the screen.
 in this manual indicates this key.

5. Send Key:

Makes or accepts calls, views the call in stand-by mode.

6. Voice Mail Key:

Press and hold this key to connect to the Voice mail centre automatically.
(Depends on the SIM card.)

**7. * /Shift Key,
Viewfinder Switch Key:**

Enters *.
Press and hold this key to switch input method among four modes: Abc, ABC, abc and 123.
Switches viewfinders between main display and external display in digital camera/video camera mode.

8. Main Display



9. Hands Free Connector

10. Right Soft Key:

Executes the function at the bottom right of the screen.
 in this manual indicates this key.

11. “Vodafone live!” Key:

Used to access “Vodafone live!” by opening the browser.

- 12. End/Power Key:** Ends a call, turns power on/off.
- 13. Keypad**
- 14. #/Flash light Key:** Switches symbol screens. Press and hold this key to shift text input method between multi-tap and T9 mode.
Turns the flash/auxiliary light on or off in digital camera/video camera mode.
- 15. Microphone**
- 16. External Connector:** Used to connect either the charger or data cable.
- 17. Aerial**
- 18. Mobile Light:** Used as a flash or an auxiliary light in digital camera/video camera mode, as a battery charge indicator, or notification for incoming calls, data/fax calls or messages.
- 19. Macro Dial: (Close-up)** Turns the dial to normal () or macro () position.
- 20. Camera**
- 21. External Display**
- 22. Infrared Port:** Sends and receives data via infrared.
- 23. Speaker**
- 24. RF Connector**
- 25. Side-Up/Side-Down Keys:** Moves cursor to select menu items, adjusts earpiece volume, etc. In stand-by mode, press and hold this key to turn the mobile light on and off. When the mobile light is on, press this key to change the light colour.
- 26. Battery Cover**

Inserting the SIM Card and the Battery

1. Slide off the battery cover.

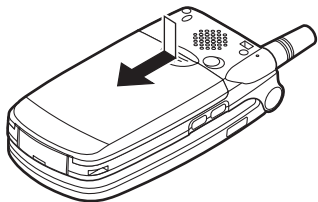

2. Slide the SIM card into the SIM holder.

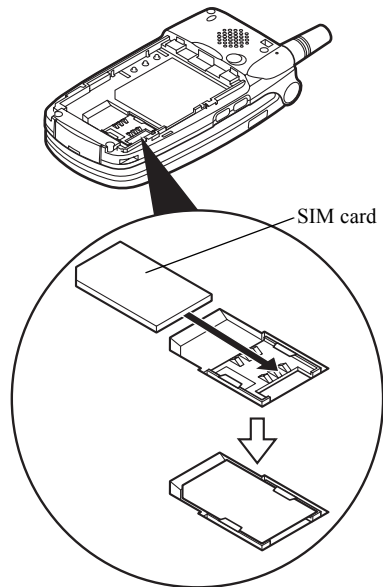

3. Hold the battery so that the metal contacts of the battery are facing down, slide the guides on the top of the battery into the battery slots ①, and then insert it ②.

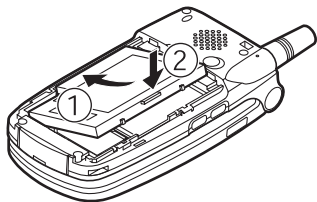

4. Replace the battery cover as shown below and slide it as shown.

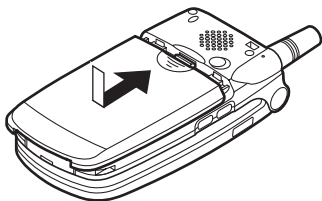

Note

- Make sure that only 3V SIM cards are used.
- Make sure that the standard accessory battery (XN-1BT11) or the optional accessory, high capacity Li-ion battery (XN-1BT13) is used.

Removing the SIM Card and the Battery

1. Make sure to turn off your phone and disconnect the charger and other accessories. Slide off the battery cover.

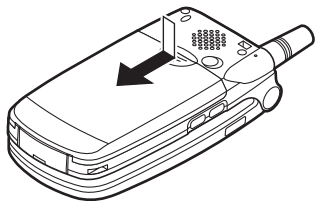

2. Pick up the battery using the protruding edge and remove the battery from the phone.

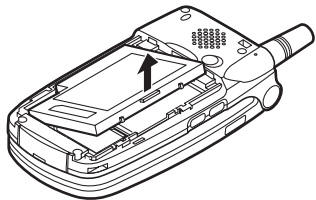

3. Slide the SIM card by pushing the back of the card and remove it from the SIM holder.

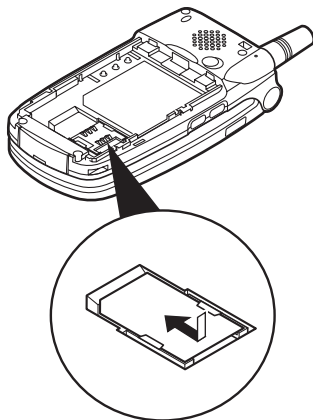

Battery Disposal

The device is supported by a battery. In order to protect the environment, please read the following points concerning battery disposal:

- Take the used battery to your local waste depot, dealer or customer service centre for recycling.
- Do not expose the used battery to an open flame, into water or dispose with the household waste.

Charging the Battery

You must charge the battery for at least 2 hours before using your phone for the first time.

Using the Charger

1. Connect the charger to the external socket located at the bottom of the phone with the charger's "PUSH TOP" mark facing you, and to an AC outlet.

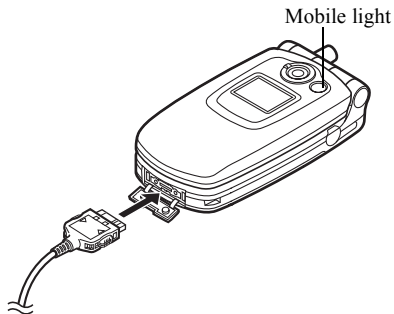

The mobile light lights red.
Standard charging time: Approx. 2 hours.

Note

- Charging time may vary depending on the state of the battery and other conditions. (See “Battery” on page 172.)

To Disconnect the Charger

Push and hold the side buttons of the charger, then disconnect the charger from the external socket of the phone.

2. When charging is complete, the mobile light turns off. Unplug the charger from the AC outlet, then unplug the charger connector from the phone.

Note

- Do not use any non approved charger, this may damage your phone and invalidate any warranty, please see “Battery” on page 172 for details.
- When the phone is charging, the animated battery status icon () in the upper right of the screen displays the current status.

To Charge Using the Cigarette Lighter Charger

The optional cigarette lighter charger supplies power for charging from the cigarette lighter socket of a car.





Battery Level Indicator

The current battery level is displayed in the upper right hand side of the main display and the external display.

Low Battery During Use

When the battery is running low, an alarm will sound and the “” is displayed on the main display and the external display.

If you are using your phone and you hear the “low battery” alarm, attach your charger as soon as possible. The phone may not be able to continue normal operation if you continue to use it. The battery may only last approximately five minutes before the phone itself powers down during a call.

Battery Indicators	Charge Level
	Sufficiently charged
	Partially charged
	Charging recommended
	Charging required
	Empty

Turning Your Phone On and Off

To turn the power on, press and hold  for approximately 2 seconds.

The stand-by screen is displayed.

To turn the power off, press and hold  for approximately 2 seconds.

To Enter the PIN Code

If activated you are asked to enter a PIN (Personal Identification Number) code after turning on your phone.

1. Enter your PIN code.
2. Press .



















Note

- If your PIN code is entered incorrectly three times in a row, the SIM card is locked. See “Enabling/Disabling the PIN Code” on page 160.

To Copy Contacts List from the SIM Card

When you insert the SIM card into your phone for the first time and start the Contacts List application, you are asked whether you wish to copy Contacts List entries on the SIM card. Follow the on-screen instructions, or you can do it later using the Contacts List menu as follows:

1. Press  to display the Main menu.





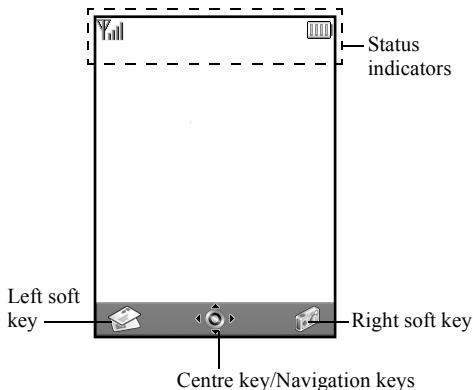









2. Press , ,  or  to highlight “Contacts”, then press  to select.
3. Press  or  to highlight “Contacts List”, then press  to select.
4. Press  [Options] to display Options menu.
5. Press  or  to highlight “Advanced”, then press  or  [Select] to select.
6. Press  or  to highlight “Copy All from SIM”, then press  to select.
7. Press  [Yes] to start copying.
To cancel copy, press  [No] in step 7.

Display Indicators (Main Display)



Status Indicators

1. / : Indicates the strength of received signal/the service is out of range.
2. : Appears when your phone is GPRS enabled and within range. Flashes during GPRS transmission.
3. / / : Appears when a new text message, multimedia message alert or WAP alert has arrived.
4. / : Appears when the application is executed (colourful) or suspended (sepia).
5. (No display) / / / / / : Indicates the phone's mode (Normal mode/Meeting mode/Activity mode/Car mode/Silent mode).
6. : Appears when the T9 text input method is activated.

7. **Abc/ABC/abc/123** : Indicates the text input method (First letter upper case mode/Upper case mode/Lower case mode/Numeric mode).
8.  : Appears when “Diverts” (p. 148) is set to “All Calls”.
9.  : Appears when the Outbox contains multimedia messages you failed to send.
10.  : Appears when viewing secured WAP browser.
11.  : Appears when in call.
12.  : Appears when the WAP or MMS communication is in CSD or GPRS mode.
13.  : Indicates the battery level.
14.  : Appears when your phone is roaming outside of your network.
15.  : Appears when “Ringer Volume” (p. 125) is set to “Silent”.
16.  : Appears when vibration (p. 126) alert is set.
17.  : Appears when the data cable is connected to your phone.
18.  : Appears when “Infrared” is on/during connection.
19.  : Appears when your phone is in data communication mode.
20.  : Appears when your phone is in fax communication mode.
21.  : Appears when a voicemail message is stored.
22.  : Appears when the alarm is set.

Soft Key Indicators

To execute the operation indicated, press the corresponding key.

23. Area at the lower left of the screen:
Displays the operation executed by left soft key.

24. Area at the lower right of the screen:

Displays the operation executed by right soft key.

Centre Key/Navigation Keys Indicators

To execute the operation indicated, press the corresponding key.

25. Area at the lower centre of the screen:

Displays the operation executed by the centre key. (For centre key options, use the Options menu displayed by the left soft key.)





26. Around the centre key indicator:

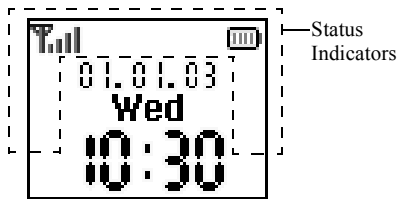









Appears when up, down, right or left navigation is available.

Display Indicators (External Display)



Status Indicators

1. : Indicates the received signal strength.
2. : Appears when GPRS is within range and can be used.
Flashes during GPRS communication mode.
3. : Appears when a new text message, multimedia message alert or WAP alert has arrived.
4. : Appears when “Ringer Volume” (p. 125) is set to “Silent”.

5.  : Appears when in call.
6.  : Appears when the WAP or MMS communication is in CSD or GPRS mode.
7.  : Indicates the battery level.
8.  : Appears when your phone is roaming outside of your network.
9.  : Appears when “Diverts” (p. 148) is set to “All Calls”.
10.  : Appears when your phone is in data communication mode.
11.  : Appears when the phone is in fax communication mode.
12.  : Appears when the alarm is set.
13.  : Appears when the data cable is connected to your phone.
14.  : Appears when “Infrared” is on/during connection.
15.  : Appears when the Outbox contains multimedia messages you failed to send.

Call Functions

Making a Call

1. Enter the area code and the phone number you wish to dial.

If you enter the wrong number, press  [Clear] to delete the number to the left of the cursor.

2. Press  to dial.



Emergency Calls

1. Enter 112 (international emergency number) using the keypad.
2. Press  to dial.

Note

- *Emergency calls may not be available on all mobile phone networks when certain network services and/or phone features are in use. Contact your network operator for more information.*
- *This Emergency number can normally be used to make an emergency call in any country, with or without a SIM card inserted, if a GSM network is within range.*



International Calls

1. Press and hold  until a “+” (international dialling prefix) sign is displayed.
2. Enter the country code, followed by the area code and the number.
3. Press  to dial.



Note

- *Enter the area code omitting the first 0 when making international calls, in most cases. (It differs for some countries.)*

Speed Dialling







Up to 9 phone numbers from the Contacts List memory (Handset and SIM) can be assigned to speed dials. You can call the numbers using the digit keys ( to  and ).

For details on setting the Speed Dial List, see “Speed Dial List” on page 45.

1. To dial a number using the speed dial, press and hold any of the digit keys ( to  and ).
The phone number stored in the Speed Dial List is dialled.



Redialling

You can redial the numbers in the call log list that you may have missed, received or dialled. Each list can contain up to 10 numbers.













1. Press  during stand-by.
2. Press  or  to highlight a category between “Dialled Numbers”, “Missed Calls” and “Received Calls”.
3. Press  or  to highlight the number you wish to call.
4. Press  to redial the call.



Automatic Redialling

This setting allows you to automatically redial the number if the first attempt was unsuccessful.

If you wish to stop redialling, press  or  [End].

To Set the Auto Redial Function

1. Press  to display the Main menu.
2. Press , ,  or  to highlight “Settings”, then press  to select.
3. Press  or  to highlight “Call Settings”, then press  to select.
4. Press  or  to highlight “Auto Redial”, then press  to select.

5. Press  or  to highlight “On” to enable the Auto Redial function or “Off” to disable it, then press .

Note

- When you receive an incoming call, the Auto Redial function is interrupted.
- Automatic redialling is not available for fax and data calls.

Ending a Call







1. Press  to end the call.

Tip

- When the hands free is connected to the phone, you can end calls by pressing the Answer button.

Answering a Call

When an incoming call is detected, the phone rings and the mobile light flashes green.

1. Open your phone.
2. Press ,  or  [Answer] to answer the call.
Or press any key except ,  [Busy],  and  when the “Any Key Answer” function is enabled.
Set the Any Key Answer function in the profile of each mode. (p. 129)

Tip

- *When the hands free is connected to the phone and the Any Key Answer function is enabled, you can answer calls by pressing the side-up or side-down key.*
- *If you have subscribed to the Calling Line Identification (CLI) service and the caller's network sends the number, the caller's number is displayed on the screen. If the caller's name and number are stored in the Contacts List, the caller's name and phone number are displayed on the screen.*
- *If the number is a restricted number, the display shows “Withheld”.*
- *When receiving a call from the person whose picture is registered in the Contacts List, receiving display and the picture are displayed alternately.*

Rejecting an Incoming Call

You can reject a call you do not wish to answer.

1. Press  or press and hold the side-up or side-down key whilst the phone is ringing.

Letting the Caller Know You are Unavailable

You can send a busy tone to the caller of an incoming call letting them know that you cannot answer the call.



1. Press  [Busy] whilst the phone is ringing.

Incall Menus

Your phone has additional functions available whilst a call is in progress.

Adjusting the Earpiece Volume

During a call, you can adjust the earpiece volume (and hands free volume, if connected).

1. During a call, press the side-up or side-down key to display the Earpiece Volume screen.
2. Press the side-up key or  to increase the volume of the call or press the side-down key or  to decrease the volume.

Five levels (level 1 to 5) are selectable.

3. Press  when the volume is set to the desired level.





The phone returns to the in-call screen automatically if left unoperated.

Putting a Call on Hold





This function allows you to manage two calls at the same time. If you wish to make another call whilst you are talking to someone, you can put the current call on hold to call someone else.

To Make Another Call during a Call

1. During a call, press  [Options] to display the Options menu.

2. Press  or  to highlight “Hold”, then press  or  [Select] to select.

The current call is put on hold.

To retrieve a call, press  [Options] and press  or  to highlight “Retrieve”, then press  or  [Select] to select.





3. Enter the phone number you wish to make another call to, then press .

Tip











- You can also make another call by entering the phone number during a call instead of steps 1 and 2. The current call is automatically put on hold.

Call Waiting





This service notifies you of another incoming call whilst you have a call in progress.

1. During a call, press  [Options] and press  or  to select “Hold & Answer”, then press  or  [Select] to answer the second call.





The first call is put on hold and you can now talk to the second caller.

2. Press  [Options] and press  or  to highlight “Swap Calls”, then press  or  [Select] to switch between the two calls.
3. Press  [Options] and press  or  to highlight “Release Call”, then press  or  [Select] to end the current call and return to the held call.

Note

- You need to set “Call Waiting” to “On” if you use the Call Waiting service (p. 145).
- Call Waiting service may not be available on all networks. Contact your network operator for more information.
- If you do not wish to answer the second call, press  [Busy], or press  [Options], then press  or  to highlight “Busy” or “Reject”, then press  in step 1. If “Reject” is selected, the call log of the second call is saved as a missed call.

Accessing SMS Menu During a Call

1. During a call, press  [Options] and press  or  to highlight “Text”, then press  or  [Select] to select.









The following options are available: “Create Message” to make an SMS, or “Inbox”, “Sent” or “Drafts” to access these folders. For details on SMS, see “Text (SMS)” on page 70.

Conference Call

Conference call is a call with more than 2 participants. You may include up to 5 participants in a conference call.

To Make a Conference Call

To make a conference call, you must have one active call and one held call.















1. Press  [Options] to display the Options menu.
2. Press  or  to highlight “Multiparty”, then press  or  [Select] to select.
3. Press  or  to highlight “Conference All”, then press  to join the conference call.
4. Press  to end the conference call.

Note







- *Conference call service may not be available on all networks. Contact your network operator for more information.*
- *You have more options for the Conference call in step 3:*
 - *To put all participants on hold, select “Conference Hold All”.*
 - *To put all participants except the current call on hold, select “Private”.*
 - *To end the call with all participants, select “Release All”.*

- *To disconnect from the conference call but still allow the other participants to continue talking together, select “Transfer”.*
- *To put the current call on hold and continue to have a conference call with the remaining participants, select “Exclude”.*
- *To reject adding more participants to the current party, select “Reject”, or you can send the busy tone by selecting “Busy”.*

To Add New Participants to the Conference Call

















1. Press  [Options] to display the Options menu.
2. Press  or  to highlight “Dial”, then press  or  [Select] to select.
3. Enter the number you wish to include in the conference call.
4. Press  to dial.
5. Press  [Options] to display the Options menu.
6. Press  or  to highlight “Multiparty”, then press  or  [Select] to select.
7. Press  or  to highlight “Conference All”, then press  to join the conference call.
If you wish to add other participants, repeat steps 1 to 7.

To End the Call with a Conference Call Participant





1. During a conference call, press  or  to highlight the person that you wish to disconnect from the conference call.
2. Press  [Options] to display the Options menu.
3. Press  or  to highlight “Release Call”, then press  or  [Select] to select.

To Have a Private Conversation with One of the Participants



If you wish to have a private conversation with one of the participants, you may select the participant from the conference list and put the other participants on hold.

1. During the conference call, press  or  to highlight the person that you wish to talk to.
2. Press  [Options] to display the Options menu.
3. Press  or  to highlight “Multiparty”, then press  or  [Select] to select.
4. Press  or  to highlight “Private”, then press  to select.
5. Once you have finished the private conversation, press  [Options] and highlight “Multiparty”, then press  or  [Select].
6. Press  or  to highlight “Conference All”, then press  to return to the conference call.

Muting the Dial Tone (DTMF Tone)

1. During a call, press  [Options] and press  or  to highlight “DTMF Tones Off”, then press  or  [Select].
To unmute the dial tone, highlight “DTMF Tones On” in step 1.

Muting the Microphone

1. During a call, press  [Mute] to mute the microphone.
To unmute the microphone, press  [Unmute].

Entering Characters

When entering characters to create Contacts List entries, text messages or multimedia messages, etc., press the corresponding keys.













In multi-tap input method, press each key until the desired character is displayed. For example, press  once for the letter “A” or twice for the letter “B”.



Table of Characters

Pressing each key scrolls characters in the following order. The order varies depending on the language selected.

English Mode

Key	Upper Case Characters	Lower Case Characters	Numeric
	. (full-stop) , (comma) - (hyphen) ? ! ' (apostrophe) @ :		1
	ABC2	abc2	2
	DEF3	def3	3
	GHI4	ghi4	4
	JKL5	jkl5	5
	MNO6	mno6	6

Key	Upper Case Characters	Lower Case Characters	Numeric
	PQRS7	pqrs7	7
	TUV8	tuv8	8
	WXYZ9	wxyz9	9
	(space)+ = < > € £ \$ ¥ % & 0		0
	*+P?		
	. , ? ! : ; - + # * @ ' " () _ & € £ \$ % / ~ < > § = \ ¥ ç i ^ [] { } □ Å Ä Æ å ä æ à Ç È é é i Ñ ñ Ò Ø ö ø ò ß Û ü ù Δ Φ Γ Λ Ω Π Ψ Σ Θ Ξ (space) ↵		

 -  : Press and hold to enter 0 - 9 numbers.











 : Press and hold to shift to Sentence mode, Upper case, Lower case or Numeric (Abc, ABC, abc or 123).

 : Press and hold to shift between multi-tap and T9 mode.

Changing the Input Languages









You can change the input language on the text entry screen.

1. On the text entry screen, press  [Options] to display the Options menu.
2. Press  or  to highlight “Input Language”, then press  or  [Select] to select.
3. Press  or  to highlight the language you wish to change, then press  to select.

Changing the Input Method



T9 Text Input



T9 text input method is a shortcut to enter text easily and quickly.

1. On the text entry screen, press  [Options] to display the Options menu.
2. Press  or  to highlight “Input Method”, then press  or  [Select] to select.
3. Press  or  to highlight the T9 mode (T9 Abc, T9 ABC, T9 abc) you wish to change, then press  to select.

“**T9**” is displayed on the main display.

4. Press each key once for any letter you require on that key.

To enter the word “How”, press   .

5. If the word shown isn't the one you want, press  or  until you highlight the correct one.
6. Press  to select the word.

Note

- *If the correct word is not shown in step 5, enter the correct word again after switching to the multi-tap input method.*

Tip

- *If you press  instead of step 6, a space is inserted next to the selected word.*













Symbols and Punctuations

To enter symbols or punctuation, press .

Using Text Templates

You can use the sentences registered in Text Templates when entering characters.















For details on creating the text template, see “Adding Phrases to Text Templates” on page 98.

1. On the text entry screen, press , ,  or  to move the cursor to the point you wish to insert the template.
2. Press  [Options] to display the Options menu.
3. Press  or  to highlight “Text Template”, then press  or  [Select] to select.
4. Press  or  to highlight the text template you wish to use, then press  to select.
The selected text template is inserted.









Copying, Cutting and Pasting Text

Using these options, you can complete editing smoothly.

To Copy and Cut Text

1. On the text entry screen, press  [Options] to display the Options menu.
2. Press  or  to highlight “Copy” or “Cut”, then press  or  [Select] to select.
3. Press  ,  ,  or  to move the cursor to the first letter to be copied or to be cut, then press .
4. Press  ,  ,  or  to move the cursor to the last letter to highlight the area, then press .







To Paste Text

1. On the text entry screen, press  ,  ,  or  to move the cursor to the point you wish to paste the letters.
2. Press  [Options] to display the Options menu.
3. Press  or  to highlight “Paste”, then press  or  [Select] to select.
Saved text is pasted.

Using the Menu

Using the Main Menu





1. Press  during stand-by.
The Main menu is displayed.
2. Press , ,  or  to navigate to required location.
3. Press  to access function.

Pressing digit keys for the menu's corresponding number also accesses function. In this manual, the operation to access function is described by navigation keys operation.

To return to the previous screen, press  [Back] if the right soft key displays [Back].

To close the Main menu, press  [Exit].

Operation Guidance

Your phone uses soft keys to help you to navigate the phone ( and ). These keys change usage depending on the situation. The function of each soft key at any given time is highlighted at the bottom left and bottom right of the screen.

The function of the centre key is displayed in the centre at the bottom of the screen by the graphical icon.

Shortcut Keys

You can shortcut to the specified menus by pressing  and digit keys for the menu's corresponding number on the Main menu. See the following table for reference. Shortcuts are listed in the headings of this manual. For example: "M 9-1-1".

Example: To Access “Language” Sub Menu Using Shortcut Keys

Press    .

Note

- *The shortcut keys work for the first three menu levels only.*

List of Menu Functions

Menu No./ Main Menu	Menu No./ Sub Menu1
1 Fun & Games	1 Games & More 2 Melody Editor
2 Vodafone live!	1 Vodafone live! 2 Games 3 Ringtones 4 Pictures 5 News 6 Sport 7 Find & Seek 8 Chat 9 Search
3 Applications	1 SIM Application* 2 Calendar 3 Alarm 4 Calculator 5 Voice Memo 6 PC Link 7 Phone Help
4 Messages	1 Multimedia 2 Text 3 Album 4 Combox & E-mail 5 Messenger 6 Cell Broadcasts 7 Area Info

Menu No./ Main Menu	Menu No./ Sub Menu1
5 Camera	1 Digital Camera 2 Video Camera
6 My Stuff	1 Games & More 2 Pictures 3 Sounds 4 Video Clips 5 Bookmarks 6 Text Templates 7 Memory Status
7 Profiles	1 Normal 2 Meeting 3 Activity 4 Car 5 Silent
8 Contacts	1 Contacts List 2 Call Log 3 Speed Dial List 4 My Numbers
9 Settings	1 Phone Settings 2 Call Settings 3 Diverts 4 Date & Time 5 Network Settings 6 Internet Settings 7 Infrared 8 Security 9 Master Reset

* Depends on SIM card contents.

Contacts List (M 8-1)

You can store the phone numbers and e-mail addresses of your friends, family and colleagues in the Contacts List.

Your phone can store up to 500 entries. In a Contacts List, you can store the following items.

Items stored in the handset memory















- Name: Up to 30 characters
- Phone number: Up to 40 digits, 3 phone numbers / entry
- E-mail Address: Up to 60 characters, 2 addresses / entry
- Group: Selectable from 7 groups
- Address: Up to 100 characters
- Note: Up to 60 characters

Items stored in the SIM memory

- Name: The number of characters that can be stored differs depending on the SIM card you use.
- Phone number: Up to 40 digits







Selecting the Contacts List Memory

You can store new entries in the Contacts Lists (either in the phone or SIM card memory) or view currently saved entries.

1. Press  to display the Main menu.
2. Press , ,  or  to highlight “Contacts”, then press  to select.
3. Press  or  to highlight “Contacts List”, then press  to select.
4. Press  [Options] to display the Options menu.
5. Press  or  to highlight “Advanced”, then press  or  [Select] to select.







The steps to be performed after step 5 differ depending on whether you wish to store new entries or view Contacts List entries.

When you store new entries

6. After performing steps 1 to 5, press  or  to highlight “Save to”, then press  to select.
7. Press  or  to highlight “Handset”, “Choice” or “SIM”, then press  to select.

When selecting “Choice”, you can choose SIM card or handset memory every time you store a new Contacts List entry.

When you wish to change the Contacts List memory











6. After performing steps 1 to 5, press  or  to highlight “Source”, then press  to select.
7. Press  or  to highlight “Handset” or “SIM”, then press  to select.

Creating a New Entry

You can choose either the phone (up to 500) or SIM card memory locations to store the new entry. For switching locations, see “Selecting the Contacts List Memory” on page 35.

The amount of phone numbers that you can store to the SIM card is dependent on its capacity. Contact your network operator for details.

If you create a new entry in the handset memory, you need to enter one of the following: “Name”, “Phone number” or “E-mail Address”. If you create a new entry on the SIM card, you need to enter: “Phone number”.











1. Perform steps 1 to 7 in “Selecting the Contacts List Memory” on page 35 to change the memory.
Steps 11 to 21 in this section cannot be performed if you use the SIM card for storing a new entry.
2. Press  to display the Main menu.
3. Press , ,  or  to highlight “Contacts”, then press  to select.
4. Press  or  to highlight “Contacts List”, then press  to select.
5. Press  [Options] to display the Options menu.





6. Press ▲ or ▼ to highlight “Add New Contact”, then press ● or [Select] to select.
If you select the “Choice” option for the memory to be used, the selection is between “Handset Entry” or “SIM Entry”.
The “New Entry” screen is displayed.
7. Press ▲ or ▼ to move the cursor to the name field, then press ●.
The name entry screen is displayed.
8. Enter a name, then press ●.
For details on entering characters, see “Entering Characters” on page 29.
9. Press ▲ or ▼ to move the cursor to the phone field, then press ●.
The phone number entry screen is displayed.
10. Enter the phone number, then press ●.
Up to 40 digits can be entered.
11. Press ▲ or ▼ to highlight a desired number type, then press ● to select.
12. Press ▲ or ▼ to move the cursor to the e-mail field, then press ●.
The e-mail address entry screen is displayed.
13. Enter an e-mail address, then press ●.

14. Press ▲ or ▼ to highlight the desired e-mail address type, then press ● to select.
15. Press ▲ or ▼ to move the cursor to the group field, then press ●.
The group selection screen is displayed.
16. Press ▲ or ▼ to highlight the desired group, then press ● to select.
17. Press ▲ or ▼ to move the cursor to the address field, then press ●.
The address entry screen is displayed.
18. Enter an address, then press ●.
19. Press ▲ or ▼ to highlight the desired address type, then press ● to select.
20. Press ▲ or ▼ to move the cursor to the note field, then press ●.
21. Enter a note, then press ●.
22. Press [Save].

Adding a Thumbnail Image to Entries

You can add a thumbnail image to entries in the handset memory.

1. Perform steps 1 to 3 in “Selecting the Contacts List Memory” on page 35.
2. Press  or  to highlight the entry to which you wish to add a thumbnail picture, then press  to select.
3. Press  [Options] to display the Options menu.
4. Press  or  to highlight “Thumbnail”, then press  or  [Select] to select.
5. Press  or  to highlight the desired picture, then press  to select.

If the picture size exceeds 240 dots [W] × 320 dots [H], press , ,  or  to specify the area you wish to display, then press .

6. Press  [Save] to save the entry.





To change the picture added, select “Change” after step 4.

To remove the picture added, select “Remove” after step 4.

Note

- If you delete an image added as a thumbnail in Saved Pictures, the corresponding thumbnail image is also removed.

Adding the Phone Number from Call Log Entries











1. Display the call log entry you wish to store (p. 130).
2. Press  [Options] to display the Options menu.
3. Press  or  to highlight “Save to Contacts”, then press  or  [Select] to select.
4. Follow the procedure from step 7 in “Creating a New Entry” on page 36.

Storing an Input Phone Number

1. Enter the phone number, then press  [Save].
2. Follow the procedure from step 7 in “Creating a New Entry” on page 36.

Copying a Single Entry from Handset to SIM Card

You can copy a single entry from the handset memory to the SIM card.

1. Perform steps 1 to 3 in “Selecting the Contacts List Memory” on page 35.
2. Press  or  to scroll list for selecting the name you wish to copy, then press  to select.
3. Press  or  to highlight the phone number you wish to copy to the SIM card.
4. Press  [Options] to display the Options menu.
5. Press  or  to highlight “Copy to SIM”, then press  or  [Select] to select.
6. Press  [Yes].











The phone number and name selected in steps 2 and 3 are copied to the SIM card.

To cancel copying an entry, press  [No] in step 6.

















Copying All Entries from SIM Card to Handset

You can copy all entries from the SIM card to the handset memory at once.

When you insert the SIM card into your phone for the first time and start the Contacts List application, the confirmation screen appears automatically, asking you if you wish to copy or not.

1. Perform steps 1 to 3 in “Selecting the Contacts List Memory” on page 35.
2. Press  [Options] to display the Options menu.
3. Press  or  to highlight “Advanced”, then press  or  [Select] to select.
4. Press  or  to highlight “Copy All from SIM”, then press  to select.
5. Press  [Yes].
To cancel copying entries, press  [No] in step 5.

Finding a Name and Number

1. Press  to display the Main menu.
2. Press , ,  or  to highlight “Contacts”, then press  to select.
3. Press  or  to highlight “Contacts List”, then press  to select.
4. Press  [Options] to display the Options menu.
5. Press  or  to highlight “Search”, then press  or  [Select] to select.
6. Enter a name or the first character(s) of the name. Matched results are displayed alphabetically. If there is no entry in the Contacts List that satisfies the exact search criteria, the name that is nearest alphabetically is displayed.
7. Press  or  to scroll through list for selecting the desired name, then press .
The details screen of the Contacts List is displayed.







Tip

- You can also find the desired name and number by entering characters using the keypad in step 4 (the screen in step 6 is displayed).
- To view the details of the item such as address, highlight the desired item, press  [Options], then

select “View”. Press  [Back] to go back the details screen.

Dialling Using Contacts List Entries



Dialling from the Contacts List Screen

1. Search for the desired Contact List entry. For details on searching through Contact List entries, see “Finding a Name and Number”.
2. On the list screen, press  or  to highlight the desired name, then press  to dial.
3. If two or more phone numbers are registered for the selected entry, press  or  to highlight the desired phone number, then press  to dial.

Tip

- You can also dial the desired phone number by pressing the digit key corresponding to the list number instead of step 3.

Dialling from the Contacts Details Screen











1. Search for the desired Contact List entry. For details on searching through Contact List entries, see “Finding a Name and Number”.
2. On the details screen, press  or  to highlight the desired phone number, then press  to dial.

Tip







- If you select “SIM” for the “Source” option in Contacts List menu (p. 35), only one phone number entry is displayed.
- If no entries are found in the list, you can create an entry from the list. Press  [Options]. Then follow the procedures as described on page 36.

Editing Contacts List Entries









You can edit Contacts List entries by searching from the Contacts List or from each Contacts List entry.

1. Search for the desired Contacts List entry.
For details on searching through Contacts List entries, see “Finding a Name and Number” on page 40.
 2. Press  [Options] to display the Options menu.
 3. Press  or  to highlight “Edit”, then press  or  [Select] to select.
 4. Press  or  to move the cursor to the item you wish to edit, then press  to select.
 5. When you have finished editing, press .
- If you wish to edit another item, repeat steps 4 to 5.
6. Press  [Save] to save the change(s).

Deleting a Single Contacts List Entry











1. Search for a desired Contacts List entry.
For details on searching through Contacts List entries, see “Finding a Name and Number” on page 40.
2. Press  [Options] to display the Options menu.
3. Press  or  to highlight “Delete”, then press  or  [Select] to select.
4. Press  [Yes].
The selected entry is deleted.
To cancel deletion, press  [No] in step 4.

Deleting All Contacts List Entries

1. Perform steps 1 to 5 in “Selecting the Contacts List Memory” on page 35.
2. Press  or  to highlight “Delete All Entries”, then press  to select.
3. Enter your handset code, then press .
4. Press  or  to highlight “Handset Entries” or “SIM Entries”, then press  to select.
5. Press  [Yes].
To cancel deletion, press  [No] in step 5.

Viewing Groups

You can set group icons when storing Contacts entries so that you can easily find and edit them.

1. Perform steps 1 to 4 in “Selecting the Contacts List Memory” on page 35.
2. Press  or  to highlight “Group”, then press  to select.
3. Press  or  to highlight “View Groups”, then press  to select.
4. Press  or  to highlight the group name you wish to view, then press  to select.
“” indicates that the group has been selected.
To cancel the selected group, press  again.
The checkbox becomes blank again.





















Tip







- In step 4, press  [Options] to display the Options menu, then select “Select Current Only” to view only the selected group or “Select All” to view all groups.

Group Call

Different ringtones can be set for each group.

When you purchase this phone, groups are set to off. If you do not set a group ringtone, the ringtone assigned in the Profiles is used.

1. Perform steps 1 to 4 in “Selecting the Contacts List Memory” on page 35.
2. Press  or  to highlight “Group”, then press  or  [Select] to select.
3. Press  or  to highlight “Group Call”, then press  to select.
4. Press  or  to highlight the group you wish to set, then press  to select.
5. Press  or  to highlight “On”, then press  to select.
6. Press  or  to highlight “Assign Melody”, then press  to select.
7. Press  or  to highlight “Preset Melodies” or “My Sounds”, then press  to select.
8. Press  or  to highlight a ringtone.
For details on selecting a ringtone, see “Assigning Melody” on page 125.















9. Press  or  to highlight “Vibration”, then press  to select.
10. Press  or  to highlight “Enable”, “Disable” or “Link to Sound”, then press  to select.
For details on setting the vibration, see “Vibration” on page 126.
11. When setting is complete, press  [OK].













Tip

- To cancel the ringtone setting, select “Off” in step 5.

Ringtone

A specified ringtone or vibration setting can be associated to a pre-registered entry.

1. Perform steps 1 to 3 in “Selecting the Contacts List Memory” on page 35.
2. Press  or  to highlight the entry you wish to set, then press  to select.
3. Press  [Options] to display the Options menu.
4. Press  or  to highlight “Ringtone”, then press  or  [Select] to select.
5. Press  or  to highlight “On”, then press  to select.
6. Press  or  to highlight “Assign Melody”, then press  to select.



7. Press  or  to highlight “Preset Melodies” or “My Sounds”, then press  to select.
8. Press  or  to highlight a ringtone.
For details on selecting a ringtone, see “Assigning Melody” on page 125.
9. Press  or  to highlight “Vibration”, then press  to select.
10. Press  or  to highlight “Enable”, “Disable” or “Link to Sound”, then press  to select.
For details on setting the vibrator, see “Vibration” on page 126.
11. Press  [OK].
12. When setting is complete, press  [Save].

Tip

- To cancel the ringtone setting, select “Off” in step 5.

Memory Status

This function helps you to check the number of entries stored in the Contacts List.









1. Perform steps 1 to 4 in “Selecting the Contacts List Memory” on page 35.
2. Press  or  to highlight “Memory Status”, then press  to select.

You can check the memory status of the SIM card and handset.

Speed Dial List

You can set a maximum of 9 phone numbers in the Speed Dial List.

Setting Contacts List entries in the Speed Dial List

1. Search for the desired Contacts List entry and display the details screen.
For details on searching through Contacts List entries, see “Finding a Name and Number” on page 40.
2. Press  or  to highlight the phone number you wish to set in the Speed Dial List.
3. Press  [Options] to display the Options menu.
4. Press  or  to highlight “Add to Speed Dial”, then press  [Select] to select.
5. Press  or  to highlight the number you wish to set, then press  to select.

Tip











- *The nine digit keys correspond to list numbers.*

Viewing the Speed Dial List

For details on viewing the speed dial list, see “Speed Dial List” on page 135.

For details on how to use the speed dial list, see “Speed Dialling” on page 21.

Sending Messages

1. Search for the desired Contacts List entry and display the details screen.
For details on searching through Contacts List entries, see “Finding a Name and Number” on page 40.
2. Press  or  to highlight the desired phone number or e-mail address of the recipient.
3. Press  [Options] to display the Options menu.
4. Press  or  to highlight “Send Message”, then press  or  [Select] to select.
5. Press  or  to highlight “Multimedia” or “Text”, then press  to select.
If you have moved the cursor to the “E-mail” field after step 1, “Multimedia” is selected automatically.
6. Enter your message.
For details on creating a message, see “Creating a New MMS” on page 59 or “Creating a New SMS” on page 70.

Swapping Location Number of the Phone Number

This function is only for entries stored on the SIM card.

1. Perform steps 1 to 3 in “Selecting the Contacts List Memory” on page 35.
2. Press ▲ or ▼ to scroll through list for selecting the desired name, then press ● to select.
3. Press ▲ or ▼ to highlight the desired phone number.
4. Press ⏻ [Options] to display the Options menu.
5. Press ▲ or ▼ to highlight “Swap”, then press ● or ⏻ [Select] to select.
6. Enter the location number you wish to swap, then press ● to select.

Camera (M 5)

Your phone incorporates an integrated digital camera. This allows you to take and send pictures or video clips wherever you are.

Digital Camera (M 5-1)

Put the phone into the digital camera mode to take a picture.

You can send the pictures registered in Saved Pictures with your message.











Picture are saved in JPEG format in the following three picture sizes.

Large: 480 × 640 dots



Medium: 240 × 320 dots

Small: 120 × 160 dots





Taking Pictures

1. Press  to display the Main menu.
2. Press , ,  or  to highlight “Camera”, then press  to select.
3. Press  or  to highlight “Digital Camera”, then press  to select.
The preview is displayed through the main display.
4. Press  or the side-down key to take the picture.

The shutter sounds and the still image of the taken picture is displayed.

5. Press  [Save].
“Saving to My Stuff...” is displayed, then the picture is registered.
If you wish to send a picture by multimedia message after taking the picture, press  before step 5.
6. Press  to return to stand-by.

Tip

- Pressing  during stand-by also activates digital camera mode.
- To leave digital camera mode without registering the taken picture after step 4 in “Taking Pictures”: Press  and Press  [Yes].
- When the distance to the subject is approximately 5 cm, set the macro dial to the macro position (). When the distance to the subject is approximately 40 cm or more, set the macro dial to the normal position ().

To Switch the Viewfinder



You can switch the viewfinder from the main display to the external display for taking a self-portrait.

Press  when the preview is displayed through the main display.



Each time you press , the viewfinder switches between the external display and the main display.

When you use the external display as the viewfinder, the taken pictures are saved automatically.

Taking Close-up Pictures

1. In digital camera mode, set the macro dial to the macro position (.
2. Press  or the side-down key to take the picture.
To cancel macro mode, set the macro dial to the normal position (.

Using the Zoom Function









Zooming ratio can be altered between “×1”, “×2”, and “×4”. Press  or  to change the zooming ratio.

Note









- When “Picture Size” is set to “Small”, you can use the zoom function in three magnifications (×1, ×2, ×4).
- When “Picture Size” is set to “Medium”, you can use the zoom function in two magnifications (×1, ×2).

- When “Picture Size” is set to “Large”, you cannot use the zoom function.

Selecting the Picture Size

1. In digital camera mode, press  [Options].
The Options menu is displayed.
2. Press  or  to highlight “Picture Size”, then press  or  [Select] to select.
3. Press  or  to highlight the picture size, then press  to select.

Selecting the Picture Quality

1. In digital camera mode, press  [Options].
The Options menu is displayed.
2. Press  or  to highlight “Picture Quality”, then press  or  [Select] to select.
3. Press  or  to highlight “Normal” or “Fine”, then press  to select.

Retaking Pictures

After steps 1 to 4 in “Taking Pictures” on page 47, press  [Cancel].

Further shooting is available.

Note

- *The digital camera uses a CCD sensor. Although this camera has been manufactured to the highest specifications, some pictures may still appear too bright or too dark.*
- *If the phone has been left in a warm place for a long time before taking or registering a picture, the picture quality may be poor.*

In the Case of No Available Memory

When the number of pictures that can be taken becomes 3 or less, the remaining shots indicator in the upper left of the screen turns red. (The number of pictures that can be taken is approximate.)

When the number of pictures that can be taken becomes 0, and when you try to take a picture again, “Memory full. You cannot take a picture!” is displayed.

Meanings of Indicators in Digital Camera Mode

Remaining shots indicator

- 123: Indicates the remaining number of pictures that can be taken.

Flash light indicators (p. 53)

Indicates when the flash light is turned on.

: Normal mode

: Macro mode

Delay timer indicator (p. 51)

: Indicates when Timer is set.

Continuous shooting indicators (p. 51)



When pictures are taken in continuous shooting mode, these indicators appear on the screen.

Picture size indicators (p. 48)

 Large: 480 × 640 dots

 Medium (default): 240 × 320 dots

 Small: 120 × 160 dots

Picture quality indicators (p. 48)

Indicates the quality (normal or fine) of the picture to be taken.



F : Fine

N : Normal

Picture brightness (exposure level) indicators (p. 50)



+2 : Bright

0 : Normal

-2 : Dark

Zooming ratio indicators (p. 48)

Indicates the magnification ($\times 1$, $\times 2$, $\times 4$).





x1 : Original size

x2 : Double size

x4 : Quadruple size

Making Adjustments According to Lighting Conditions









To Adjust the Brightness of the Picture

Press  or  to adjust the brightness of the picture.

Once the phone has returned to the stand-by screen the brightness settings return to default.

Viewing the Taken Pictures

Taken pictures can be viewed in Saved Pictures.











1. In digital camera mode, press  [Options].
The Options menu is displayed.
2. Press  or  to highlight “My Pictures”, then press  or  [Select] to select.
The list of Saved Pictures is displayed.
3. Press  or  to highlight the file name you wish to view, then press  to select.
The selected picture is displayed.
4. Once you have finished, press  [Back] to return to the list.

Tip







- Your pictures are given file names which are “pic_nnn.jpg” (nnn is a three-digit consecutive number).
The file name, date and size of your pictures are displayed in the list of Saved Pictures.

Using the Timer









To Take a Picture with the Timer

1. In digital camera mode, press  [Options].
The Options menu is displayed.
2. Press  or  to highlight “Delay Timer”, then press  or  [Select] to select.
3. Press  or  to highlight “On”, then press  to select.
“” is displayed on the screen and the phone returns to digital camera mode.
4. Press  or the side-down key to start the delay timer.
10 seconds after the timer sounds, the shutter sounds, and the camera takes a picture.

Note









- Whilst the delay timer is operating, the flash light and the indicator flash.
- If  or the side-down key is pressed whilst the delay timer is operating, the picture is taken instantly.
- The zoom function with  or , or brightness adjustment of the picture with  or , is unavailable whilst the delay timer is operating.
- If you wish to stop taking pictures with the timer, press  [Cancel] whilst the delay timer is operating.

Cancelling the Delay Timer

1. Press  [Options] whilst the delay timer setting is on.
The Options menu is displayed.
2. Press  or  to highlight “Delay Timer”, then press  or  [Select] to select.
3. Press  or  to highlight “Off”, then press  to select.
“” goes off.

Continuous Shooting

Four pictures are taken in succession. Auto Shooting and Manual Shooting are available.

1. In digital camera mode, press  [Options].
The Options menu is displayed.
2. Press  or  to highlight “Continuous Shooting”, then press  or  [Select] to select.
3. Press  or  to highlight “Auto Shooting” or “Manual Shooting”, then press  to select.
To cancel Continuous Shooting, select “Off”.
4. Press  or the side-down key to start continuous shooting.

Auto Shooting: Four pictures are taken in a row by pressing  or the side-down key.

Manual Shooting: Pictures are taken one by one by pressing  or the side-down key.

When the Continuous Shooting is completed, the taken pictures are saved automatically.











To stop Continuous Shooting, press  [Cancel].

Note

- When “Picture Size” is set to “Large”, you cannot use the Continuous Shooting function.
- When you select a frame for taking pictures, you cannot use the Continuous Shooting function.

Selecting a Frame









You can select the frame from preset patterns. You can also select a frame in Saved Pictures.

1. In digital camera mode, press  [Options].
The Options menu is displayed.
2. Press  or  to highlight “Add Frame”, then press  or  [Select] to select.
3. Press  or  to highlight “Preset Frames” or “My Pictures”, then press  to select.
4. Press  or  to highlight the frame you wish to use, then press  to select.



Note

- When “Picture Size” is set to “Large”, you cannot use the Frame function.
- When you activate the Continuous Shooting function, you cannot use the Frame function.
- Only the images of PNG format can be selected as the frame if you select “My Pictures” in step 3.

Selecting Light Colour









1. In digital camera mode, press  [Options].
The Options menu is displayed.
2. Press  or  to highlight “Light Colour”, then press  or  [Select] to select.
3. Press  or  to highlight the desired colour, then press  to select.
To turn off the flash light, select “Off”.

Tip

- Each time  or the side-up key is pressed, the status of the flash light changes as follows.
Off → On (brightness for normal mode: ) → On (brightness for macro mode: ) → Off
- If you do not operate your phone for approximately one minute, the flash light turns off automatically to save the power.

Selecting the Shutter Sound

You can select the shutter sound from 3 preset patterns.

1. In digital camera mode, press  [Options].
The Options menu is displayed.
2. Press  or  to highlight “Shutter Sound”, then press  or  [Select] to select.
3. Press  or  to highlight the desired sound, then press  to select.
To play back the shutter sound, press  [Play] in step 3.

Sending Pictures

To send your picture to another phone or e-mail address, see “Sending Messages” on page 91 for instructions.

Deleting Pictures

See “Deleting Pictures” on page 91 for instructions.

Video Camera (M 5-2)









Put the phone into the video camera mode to record a video clip.

You can send video clips registered in Saved Video Clips with your message.

Video clips are saved in “.3gp” format.

Recording Video Clips

Sound can be recorded with the video clip.



1. Press  to display the Main menu.
2. Press , ,  or  to highlight “Camera”, then press  to select.
3. Press  or  to highlight “Video Camera”, then press  to select.

The preview is displayed through the main display.

4. Press  or the side-down key to start recording the video clip.

The sound for recording the video clip occurs.

If you press  or the side-down key again, or when the recording is completed, the sound for ending the video clip recording occurs and the display transits to step 5.

5. Press  or  to highlight “Save”, then press  to select.

“Saving to My Stuff...” is displayed, then the video clip is registered.

If you preview a video clip before saving, select “Preview” in step 5.



If you wish to send a video clip by multimedia message after recording the video clip, select “Send Message” in step 5.

To Switch the Viewfinder

Press  when the preview is displayed through the main display.



Each time you press , the viewfinder switches between the external display and the main display.

Recording Close-up Video Clips









1. In video camera mode, set the macro dial to the macro position (.
2. Press  or the side-down key to start recording the video clip.

To cancel macro mode, set the macro dial to the normal position (.

Using the Zoom Function

Zooming ratio can be altered. Press  or  to change the zooming ratio.

Selecting Video Quality

1. In video camera mode, press  [Options].
The Options menu is displayed.
2. Press  or  to highlight “Video Quality”, then press  or  [Select] to select.
3. Press  or  to highlight “Normal” or “Fine”, then press  to select.

In the Case of No Available Memory

When the number of video clips that can be recorded becomes 3 or less, the remaining sets indicator in the upper left of the screen turns red. (The number of sets that can be recorded is approximate.)

When the number of video clips that can be recorded becomes 0, and when you try to record a video clip again, “Memory full. You cannot record a video!” is displayed.

Meanings of Indicators in Video Camera Mode

Remaining sets indicator

123: Indicates the remaining sets of video clips that can be recorded.

Flash light indicators (p. 58)

Indicates when the flash light is turned on.

: Normal mode

: Macro mode

Delay timer indicator (p. 57)

: Indicates when Timer is set.

Video camera indicator

: Displays when the phone is in video camera mode.

Video quality indicators (p. 55)

Indicates the quality (normal or fine) of the video clip to be recorded.

: Fine

: Normal

Video brightness (exposure level) indicators (p. 56)

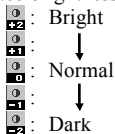

Zooming ratio indicators (p. 55)

Indicates the magnification ($\times 1$, $\times 2$, $\times 4$).

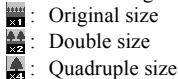

Making Adjustments According to Lighting Conditions

To Adjust the Brightness of the Video Clips

Press or to adjust the brightness of the video clip.

Once the phone has returned to the stand-by screen, the brightness settings return to default.

Viewing Recorded Video Clips

Recorded video clips can be viewed in Saved Video Clips.

1. In video camera mode, press [Options].
2. Press or to highlight “My Video Clips”, then press or [Select] to select.
The list of Saved Video Clips is displayed.
3. Press or to highlight the file name you wish to view, then press to select.
4. Press .

The selected video clip is played back.

To pause playback, press .



To resume playback, press again.

To stop playback, press [Back].

To display the video clip in actual size, press [$\times 1$].









5. Once you have finished, press  [Back] to return to the list.

Tip

- Your video clips are given file names which are “mov_nnn.3gp” (nnn is a three-digit consecutive number).
The file name, date and size of your video clips are displayed in the list of Saved Video Clips
- If the video clip has been recorded with sound, the volume can be adjusted by pressing  or .
- The volume depends on the settings of Ringer Volume (p. 125). The volume becomes 0 when “Ringer Volume” is set to “Silent” or “Step Tone”.







Using the Timer

To Record a Video Clip with the Timer









1. In video camera mode, press  [Options].
The Options menu is displayed.
2. Press  or  to highlight “Delay Timer”, then press  or  [Select] to select.
3. Press  or  to highlight “On”, then press  to select.
“” is displayed on the screen and the phone returns to video camera mode.

4. Press  or the side-down key to start the delay timer.
10 seconds after the timer sounds, the camera starts recording the video clip.









Note

- Whilst the delay timer is operating, the flash light and the indicator flash.
- If  or the side-down key is pressed whilst the delay timer is operating, the video clip is recorded instantly.
- The zoom function with  or , or brightness adjustment of the video with  or , is unavailable whilst the delay timer is operating.
- If you wish to stop recording video clips with the timer, press  [Cancel] whilst the delay timer is operating.









Cancelling the Delay Timer

1. Press  [Options] whilst the delay timer setting is on.
The Options menu is displayed.
2. Press  or  to highlight “Delay Timer”, then press  or  [Select] to select.
3. Press  or  to highlight “Off”, then press  to select.
“” goes off.



Recording Video Clips with Sound

1. In video camera mode, press  [Options].
The Options menu is displayed.
2. Press  or  to highlight “Voice Record”, then press  or  [Select] to select.
3. Press  or  to highlight “On”, then press  to select.
To cancel recording video clips with sound, select “Off” in step 3.

Selecting Light Colour

1. In video camera mode, press  [Options].
The Options menu is displayed.
2. Press  or  to highlight “Light Colour”, then press  or  [Select] to select.
3. Press  or  to highlight the desired colour, then press  to select.
To turn off the flash light, select “Off”.

Tip

- Each time  or the side-up key is pressed, the status of the flash light changes as follows.
Off → On (brightness for normal mode: ) → On (brightness for macro mode: ) → Off

- *If you do not operate your phone for about one minute, the flash light turns off automatically to save power.*

Sending Video Clips

To send your video clips to another phone or e-mail address, see “Sending Messages” on page 96 for instructions.

Deleting Video Clips

See “Deleting Video Clip files” on page 97 for instructions.

Messages (M 4)

Your phone allows you to send and receive text messages or multimedia messages and to receive WAP alerts.

Multimedia (MMS) (M 4-1)









About Multimedia Messaging









Multimedia Messaging Service (MMS) allows you to send and receive multimedia messages with graphical images, photographs, sound, animations or video clips attached.

Note

- *Some MMS functions may not always be available depending on your network. Contact your network operator for more information.*

Creating a New MMS (M 4-1-1)





1. Press  during stand-by.
2. Press  or  to highlight “Multimedia”, then press  to select.
3. Press  or  to highlight “Create Message”, then press  to select.
4. Enter your message, then press .

5. Enter the phone number or e-mail address of the recipient, then press .
If you wish to select a phone number or e-mail address in the Contacts List, search for the desired Contacts List entry.
Press  or  to display the Contacts List, and press  or  to select the desired name, then press . For details on searching the Contacts List entries, see “Finding a Name and Number” on page 40.
6. Press  or  to highlight “Send”, then press  to select.
The message is put in the Outbox and sent.
After the message is sent, the message is moved to the Sent box.

Note

- *The current message size displayed whilst you are creating the message is an approximation.*
- *If a message cannot be sent for some reason, the message stays in the Outbox and “” is displayed on the stand-by screen.*

To Enter the Subject of the Message











1. Perform steps 1 to 5 in “Creating a New MMS” on page 59.
2. Press  or  to highlight “Subject”, then press  to select.
3. Enter the subject of your message, then press .

Note

- *This phone allows you to enter up to 40 characters as the subject, and enter up to 20 addresses (for To and Cc). However, these may be limited depending on your network. In this case, you may not be able to send MMS. Contact your network operator for more information.*

To Send a Message Template MMS

Your phone provides message templates with an image and voice attachment that help you create easily.

1. Perform steps 1 to 3 in “Creating a New MMS” on page 59.
2. Press  [Options] to display the Options menu.
3. Press  or  to highlight “Message Template”, then press  or  [Select] to select.
A confirmation screen asking whether you wish to discard the current text is displayed.
4. Press  [Yes] to discard.
To cancel, press  [No] in step 4.
5. Press  or  to highlight a template you wish to send, then press .
6. Perform steps 4 to 6 in “Creating a New MMS” on page 59.

Note

- *Selecting “Message Template” deletes messages or images you have entered or attached. To prevent deletion, select “Message Template” first, then enter messages.*

To Add Recipients

1. Perform steps 1 to 5 in “Creating a New MMS” on page 59.
2. Press ▲ or ▼ to highlight “Add Contact”, then press ● to select.
3. Press ▲ or ▼ to highlight “To” to add recipients or “Cc” to send a copy of this MMS to other recipients, then press ● to select.
4. Press ▲ or ▼ to highlight a desired number from the list, then press ● to select.
5. Enter the phone number or e-mail address of the other recipients, then press ●.
6. Press ⏪ [Back] twice.

To Use the Text Template

For details on creating text templates, see page 98.

1. Perform steps 1 to 3 in “Creating a New MMS” on page 59.
2. Press ▲, ▼, ◀ or ▶ to move the cursor to the point you wish to insert the template.
3. Press ⏺ [Options] to display the Options menu.
4. Press ▲ or ▼ to highlight “Text Template”, then press ● or ⏺ [Select] to select.

5. Press ▲ or ▼ to highlight the desired template from the list, then press ● to select.

To Save a Message in the Drafts Box













You can save a message in the Drafts box temporarily and send it later.

1. Perform steps 1 to 5 in “Creating a New MMS” on page 59.
2. Press ▲ or ▼ to highlight “Save to Drafts”, then press ● to save the message in the Drafts box.

Note

- You can send it later following the instructions in “Sending a Message in the Drafts Box” on page 63.

Turning the Slide Show Setting On or Off

1. Press  during stand-by.
2. Press  or  to highlight “Multimedia”, then press  to select.
3. Press  or  to highlight “Settings”, then press  to select.
4. Press  or  to highlight “Slide Show”, then press  to select.
5. Press  or  to highlight “On” or “Off”, then press  to select.

If You Select “On”















- *You can create messages which have up to 10 slides. Each slide can contain one picture, one sound file and up to 1000 characters of text (up to the message total 100 Kbytes limit).*
- *The slide control options available are:*
 - Add: To add a new slide.*
 - Remove: To remove the active slide.*
 - Previous: To navigate to the previous slide.*
 - Next: To navigate to the next slide.*
- *EVA (e-Animation file) and video clip data cannot be attached as slide data to the message.*

If You Select “Off”

- *You can attach a maximum of 20 pictures, sounds or video clips and up to 100 Kbytes in total.*

Inserting Attached Data

You can send pictures, sounds and video clips saved in Saved Pictures, Saved Sounds or Saved Video Clips attached to multimedia messages. When attaching video clips, “Slide Show” must be set to “Off”.

1. Press  during stand-by.
2. Press  or  to highlight “Multimedia”, then press  to select.
3. Press  or  to highlight “Create Message”, then press  to select.
4. Press  [Options] to display the Options menu.
5. Press  or  to highlight “Picture”, “Sound” or “Video Clip”, then press  or  [Select] to select.
6. Press  or  to highlight the file name you wish to attach, then press  to select.









The selected picture/sound/video clip is attached. When attaching is complete, press  [Back] to return to the message creation screen.

To Add Attached Data

You can perform the following with the slide show setting off.

1. Perform step 1 to 5 in “Inserting Attached Data” on page 62.









The list of attached data is displayed.

2. Press  [Options] to display the Options menu.
3. Press  or  to highlight “Add Picture”, “Add Sound” or “Add Video Clip”, then press  or  [Select] to select.
4. Press  or  to highlight the file name you wish to attach, then press .
5. Press  [Back].

To Remove Attached Data



















1. Perform steps 1 to 5 in “Inserting Attached Data” on page 62.

The list of attached data is displayed.

2. Press  or  to highlight the file name you wish to remove, then press  [Options].
3. Press  or  to highlight “Remove”, then press  or  [Select] to select.
4. Press  [Yes].

To cancel removal, press  [No] in step 4.

Sending a Message in the Drafts Box

1. Press  during stand-by.
2. Press  or  to highlight “Multimedia”, then press  to select.
3. Press  or  to highlight “Drafts”, then press  to select.
4. Press  or  to highlight the message you wish to send in the Drafts box, then press  [Options]. The Options menu is displayed.
5. Press  or  to highlight “Edit Message”, then press  or  [Select] to select.
6. Modify the message, then press .
7. Modify the phone number or e-mail address of the recipients, then press .
8. Press  or  to highlight “Send”, then press  to select.

Note







- You cannot modify a Slide Show message that is created on another phone as shown in step 6. Go to step 7.

Reading MMS



Messages you receive are stored in the Inbox.

Incoming Messages



The MMS indicator () will appear when you are receiving an incoming message.

1. Press  during stand-by.
2. Press  or  to highlight “Multimedia”, then press  to select.
3. Press  or  to highlight “Inbox”, then press  to select.







Messages that are marked with a clip denote mails with attachments.

4. Press  or  to highlight the message you wish to view, then press  to select.

The message is displayed.

















5. Press  or  to scroll the screen to read the message.
6. When you finish viewing, press .

To Check the Sender and Receiver Phone Number or E-mail Address

1. Perform steps 1 to 3 in “Incoming Messages”.
2. Press  or  to highlight the desired message, then press  [Options] to display the Options menu.
3. Press  or  to highlight “Details”, then press  or  [Select] to select.

The sender’s phone number or e-mail address, time and date stamp, subject and size are displayed.













Replying to a Message from the Sender from the Inbox

1. Press  during stand-by.
2. Press  or  to highlight “Multimedia”, then press  to select.
3. Press  or  to highlight “Inbox”, then press  to select.
4. Press  [Options] to display the Options menu.
5. Press  or  to highlight “Reply”, then press  or  [Select] to select.
6. Enter your message.
For details on entering characters, see “Entering Characters” on page 29.
7. Press .
The phone number or e-mail address of the recipient is automatically filled in the sender’s phone number or e-mail address.
8. Press .
The subject field is automatically filled in with the original subject preceded by “Re:”.
9. Press  or  to highlight “Send”, then press  to select.

Tip

- You can reply to a message to all addresses of selected messages by selecting “Reply All” in step 5.







Forwarding a Message

1. Perform steps 1 to 4 in “Replying to a Message from the Sender from the Inbox”.
2. Press  or  to highlight “Forward”, then press  to select.
3. Enter the phone number or e-mail address of the recipient, then press .
If you wish to select the phone number or e-mail address in the Contacts List, search for the desired Contacts List entry.
Press  or  to display the Contacts List, and press  or  to select the desired name, then press . For details on searching the Contacts List entries, see “Finding a Name and Number” on page 40.
4. Press  or  to highlight “Send”, then press  to select.

Note

- When a message with attached data is forwarded the data is also sent. However, if there is any data which the phone recognises as having copyright, then it will not be sent.
- The “Subject” field is automatically filled in with the original subject preceded by “Fw:”. The original message cannot be changed.



Modifying a Message

1. Perform steps 1 to 4 in “Replying to a Message from the Sender from the Inbox” on page 65.
2. Press  or  to highlight “Edit Message”, then press .
3. Modify the message.
4. Press .
5. Press  or  to highlight “Send”, then press  to select.

Note

- Messages cannot be edited if they contain particular data such as Slide Show, XHTML, copyrights or an unknown format.











Storing the Phone Number or E-mail Address of a Sender in the Contacts List

1. Perform steps 1 to 4 in “Replying to a Message from the Sender from the Inbox” on page 65.
2. Press  or  to highlight “Save to Contacts”, then press .

For details on entering a name, see “Creating a New Entry” on page 36.

Retrieving MMS

When “











1. Perform steps 1 and 2 in “Creating a New MMS” on page 59.
2. Press  or  to highlight “Inbox”, then press .
3. Press  or  to highlight the alert you wish to download.
4. Press  [Options] to display the Options menu.
5. Press  or  to highlight “Download”, then press  or  [Select] to select.

Tip











- You can press  instead of steps 4 and 5 to start downloading.

Re-sending a Message in the Outbox (M 4-1-5)

If a message cannot be sent for some reason, the message stays in the Outbox. Messages in the Outbox can be resent.















1. Perform steps 1 and 2 in “Creating a New MMS” on page 59.
2. Press  or  to highlight “Outbox”, then press  to select.
3. Press  or  to highlight the message you wish to re-send in the Outbox, then press  [Options].
4. Press  or  to highlight “Re-send”, then press  or  [Select] to select.

Confirming Arrival of Delivery Report

1. Perform steps 1 and 2 in “Creating a New MMS” on page 59.
2. Press  or  to highlight “Sent”, then press  to select.
3. Press  or  to highlight the message of which you wish to confirm arrival of delivery report, then press  [Options] to display the Options menu.
4. Press  or  to highlight “Delivery Report”, then press  or  [Select] to select.

This menu is available only for sent messages that have the “Delivery Report” set to “On”. For details on selecting “Delivery Report”, see “Setting Up MMS” on page 69.











Deleting Messages

1. Perform steps 1 and 2 in “Creating a New MMS” on page 59.
2. Press  or  to highlight “Inbox”, “Sent”, “Drafts” or “Outbox”, then press  to select.
3. Press  or  to highlight the message you wish to delete, then press  [Options].
The Options menu is displayed.
4. Press  or  to highlight “Delete”, then press  or  [Select] to select.
The confirmation screen is displayed.
5. Press  or  to highlight “One Message” or “All Messages”, then press  to select.
6. Press  [Yes].
To cancel deletion, press  [No] in step 6.

Note





- You cannot delete locked messages.

To Lock Message











1. Perform steps 1 and 2 in “Creating a New MMS” on page 59.
2. Press  or  to highlight “Inbox” or “Sent”, then press  to select.
3. Press  or  to highlight the message you wish to lock, then press  [Options].
The Options menu is displayed.
4. Press  or  to highlight “Lock/Unlock”, then press  or  [Select] to select.

Making a Call to the Sender of a Message

You can make a call to the sender of a message in the Inbox whose address (From) is the phone number.

1. Perform steps 1 to 3 in “Replying to a Message from the Sender from the Inbox” on page 65.
2. Press  [Options] to display the Options menu.
3. Press  or  to highlight “Call Sender”, then press  or  [Select] to select.

Setting Up MMS (M 4-1-6)

1. Press  during stand-by.
2. Press  or  to highlight “Multimedia”, then press  to select.
3. Press  or  to highlight “Settings”, then press  to select.
4. Press  or  to highlight the desired item, then press  to select.

The items available are:

- Roam. Download:
Defers MMS download method when roaming outside of your network.
- Delivery Rep. Allow:
Enables Delivery Report when receiving a message which applies to the Delivery Report function.
- Anonymous Reject:
Rejects a messages from an unknown or empty address name.
- Auto Delete:
Deletes the oldest message automatically, when the Sent is full.

- Slide Show:
Enables Slide Show when sending a message.
- Advanced
 - Priority:
Prioritises composed messages.
 - Delivery Report:
Enables Delivery Report.
 - Expiry Time:
Sets Expiry Time for a message to be stored in the Server.
 - Sender Visibility:
Displays the information about the sender.
 - Slide Interval:
Sets the slide display time when sending a message.
- 5. Change each item.
- 6. When you finish setting, press  [Back].

Text (SMS) (M 4-2)

About Text Messaging

The Short Message Service (SMS) allows you to send text messages of up to 1024 characters to other GSM users.







To Use SMS with Your Phone

Messages longer than 160 characters may be composed. During sending, the messages are split. If the receiver has a suitable phone the messages recombines during reception, if not your message appears as a number of separate 152 characters messages.

You can send or receive SMS even if you are talking on the phone.

You can also use Text Templates to help you compose SMS.

Creating a New SMS (M 4-2-1)

1. Press  during stand-by.
2. Press  or  to highlight “Text”, then press  to select.
3. Press  or  to highlight “Create Message”, then press  to select.













4. Enter your message.

For details on entering characters, see “Entering Characters” on page 29.





5. Press .

To Use the Text Template









For details on creating text templates, see “Text Templates” on page 98.

1. Perform steps 1 to 3 in “Creating a New SMS”.
2. On the text entry screen, press , ,  or  to move the cursor to the point you wish to insert the template.
3. Press  [Options] to display the Options menu.
4. Press  or  to highlight “Text Template”, then press  or  [Select] to select.
5. Press  or  to highlight the desired template from the list, then press  to select.





To Save the Message in the Drafts box



1. Perform steps 1 to 5 in “Creating a New SMS”.
2. Enter the phone number of the recipient, then press .
3. Press  or  to highlight “Save to Drafts”, then press  to select.

Sending a Message

1. Press  during stand-by.
2. Press  or  to highlight “Text”, then press  to select.
3. Press  or  to highlight “Create Message”, then press  to select.
4. Enter your message.
For details on entering characters, see “Entering Characters” on page 29.
5. Press .
6. Enter the phone number of the recipient, then press .



If you wish to select the phone number in the Contacts List, search for the desired Contacts List entry.

Press  or  to display the Contacts List, and press  or  to select the desired name, then press . For details on searching the Contacts List entries, see “Finding a Name and Number” on page 40.









7. Press  or  to highlight “Send”, then press  to select.

The phone begins the sending process and the SMS is sent. After the message has been sent, the message is added to the Sent box.

Note

- *When you send a message of more than 160 characters, the confirmation message is displayed. Press  [Yes] to send or  [No] to cancel.*

To Add Recipients



1. Perform steps 1 to 6 in “Sending a Message” on page 71.
2. Press  or  to highlight “Add Contact”, then press  to select.
3. Press  or  to highlight an item number for adding recipient’s phone number, then press  to select.
4. Enter the phone number to add, then press .
5. When adding recipients is complete, press  [Back].

Follow the procedure from step 7 in “Sending a Message” on page 71.



Reading SMS





Incoming Messages

The SMS indicator () will appear when an incoming message arrives.







1. When you receive a SMS, press  during stand-by.
2. Press  or  to highlight the message you wish to view.

The sender’s phone number and a part of the message are displayed. When the sender’s phone

number is stored in the Contacts List, the sender’s name is displayed instead of the phone number. Messages are marked with “” denote unread messages. If the Inbox, Sent box or Drafts box is full, “” is displayed. Delete unnecessary messages.





3. Press .
4. Press  or  to scroll the screen to read the message.
5. When you have finished viewing, press .

Replying to the Sender







1. Perform steps 1 to 3 in “Reading SMS”.
2. Press  [Options] to display the Options menu.
3. Press  or  to highlight “Reply”, then press  or  [Select] to select.
4. Enter your message.
For details on entering characters, see “Entering Characters” on page 29.
5. Press .

Follow the procedure from step 6 in “Sending a Message” on page 71.



Calling the Message Sender

1. Perform steps 1 to 3 “Reading SMS” on page 72.
2. Press  [Options] to display the Options menu.
3. Press  or  to highlight “Call Sender”, then press  or  [Select] to select.

Forwarding a Message













1. Perform steps 1 to 3 in “Reading SMS” on page 72.
2. Press  [Options] to display the Options menu.
3. Press  or  to highlight “Forward”, then press  or  [Select] to select.
4. Enter the phone number of the recipient, then press .

For details on searching the Contacts List entries, see “Finding a Name and Number” on page 40.

5. Press  or  to highlight “Send”, then press  to select.
6. Follow the procedure from step 7 in “Sending a Message” on page 71.

















The phone begins the sending process and the SMS is sent.

Modifying a Message

1. Perform steps 1 and 2 in “Creating a New SMS” on page 70.
2. Press  or  to highlight “Inbox”, “Sent” or “Drafts”, then press  to select.
3. Press  or  to highlight the message you wish to modify, then press  to select.
4. Press  [Options] to display the Options menu.
5. Press  or  to highlight “Edit”, then press  or  [Select] to select.
6. Modify the message, then press .















Follow the procedure from step 6 in “Sending a Message” on page 71.

Deleting Messages

1. Perform steps 1 and 2 in “Creating a New SMS” on page 70.
2. Press  or  to highlight “Inbox”, “Sent” or “Drafts”, then press  to select.
3. Press  or  to highlight the message you wish to delete, then press  to select.
4. Press  [Options] to display the Options menu.
5. Press  or  to highlight “Delete”, then press  or  [Select] to select.
6. Press  or  to highlight “One Message” or “All Messages”, then press  to select.
7. Press  [Yes].
The selected message or all messages are deleted.
To cancel deletion, press  [No] in step 6.

Extracting Phone Numbers from the Received Messages and Making a Call

You can make a call using the phone number embedded in the received SMS message.

1. Perform steps 1 and 2 in “Reading SMS” on page 72.
2. Press  [Options] to display the Options menu.
3. Press  or  to highlight “Extract Numbers”, then press  or  [Select] to select.
Telephone numbers embedded in the message are displayed.
4. Press  or  to highlight the number, then press  [Options] to display the Options menu.
5. Press  or  to highlight “Make Call”, then press  to select.
To save this phone number in the Contacts List, press  or  to highlight “Save to Contacts”, then press  to select.
For details on entering a name, see “Creating a New Entry” on page 36.











Tip

- Selecting “Save to Contacts” in step 3 instead allows you to go to the phone number entry screen with the sender’s number entered.

For details on entering a name, see “Creating a New Entry” on page 36.

Setting Up SMS (M 4-2-5)

To Set Up the Service Centre Address

1. Press  during stand-by to display the Message menu.
2. Press  or  to highlight “Text”, then press  to select.
3. Press  or  to highlight “Settings”, then press  to select.
4. Press  or  to highlight “Message Centre”, then press  to select.
5. Enter the centre number (+41 79 4999 000).







If you wish to enter a country code for a message to an international number, press and hold  until a “+” sign is displayed.

6. Press .







Message Lifetime

This indicates the number of days and hours for which a message you send may remain undelivered to the message recipient.







During this period, the message service centre will continually try to deliver the message to the recipient.

1. Perform steps 1 to 3 in “Setting Up SMS”.
2. Press  or  to highlight “Message Lifetime”, then press  to select.
3. Press  or  to highlight the validity period, then press  to select.

Message Format

1. Perform steps 1 to 3 in “Setting Up SMS”.
2. Press  or  to highlight “Message Format”, then press  to select.
3. Press  or  to highlight the message format, then press  to select.

Connection Type







1. Perform steps 1 to 3 in “Setting Up SMS” on page 75.
2. Press  or  to highlight “Connection Type”, then press .
3. Press  or  to highlight the connection type, then press .

Optimisation

When set “On” (default), double-byte characters such as European characters with an accent are converted into single-byte characters and sent.

When “Off”, double-byte characters are sent as displayed.

Please note that you may be charged double for double-byte characters sent in an SMS when Optimisation is set “Off”.











1. Perform steps 1 to 3 in “Setting Up SMS” on page 75.
2. Press  or  to highlight “Optimisation”, then press .
3. Press  or  to highlight “On” or “Off”, then press .

Cell Broadcasts (M 4-6)





You can receive Cell Broadcast messages or general messages such as weather forecasts and traffic reports. This information is broadcast to subscribers in certain network areas.

This function may not be available on all mobile phone networks. Contact your network operator for more information.

Enabling/Disabling Cell Broadcasts (M 4-6-1)

















1. Press  during stand-by.
2. Press  or  to highlight “Cell Broadcasts”, then press .
3. Press  or  to highlight “On/Off”, then press .
4. Press  or  to highlight “On” to set Cell Broadcasts on or “Off” to set it off, then press  to select.

Reading Cell Broadcast Messages (M 4-6-2)

1. When you receive a Cell Broadcast message, press .
2. Press  or  to scroll the screen to read the message.
3. When you finish viewing, press .

Subscribing to Cell Broadcasts (M 4-6-3)

Select the page of the cell broadcast message that you want.









1. Press  during stand-by.
2. Press  or  to highlight “Cell Broadcasts”, then press .
3. Press  or  to highlight “Settings”, then press .
4. Press  or  to highlight “Set Info Subjects”, then press .
5. Press  or  to highlight “Add/Remove”, then press .
6. Press  or  to highlight the desired page, then press .
7. Press  [Back].

Tip

- If the desired page is not in the list that appears in step 6, select “Create Subject” in step 5, then enter the subject code to add a page. For details on the subject code, contact your service provider.

Setting Languages

Allows you to select your preferred language for the cell broadcast message display.

1. Perform steps 1 to 3 in “Subscribing to Cell Broadcasts”.
2. Press  or  to highlight “Language”, then press .
3. Press .
- The language list is displayed.
4. Press  or  to highlight the language you wish to set, then press .
5. Press  [Back] to exit.

Area Info (M 4-7)







The Area Info is the message information that operators sent to subscribers in certain areas.

When you receive Area Info, the message (area code) is displayed on the stand-by screen.

Note

- *This function may not be available on all mobile phone networks. Contact your network operator for more information.*

Enabling/Disabling Area Info

1. Press  during stand-by.
2. Press  or  to highlight “Area Info”, then press  to select.
3. Press  or  to highlight “On” or “Off”, then press  to select.

Note

- *If Area Info is set to “On”, the stand-by time will decrease.*

Vodafone live! (M 2)

Your phone is already configured to access Vodafone live! and the mobile internet*.

Customised for



Vodafone live! is a new mobile internet portal which is your gateway to a new world of information, games, music and services.

Because your phone uses GPRS, a system that is much faster than previous ways of getting mobile information. Also, the connection is 'always on' which means there is no need to wait for dialling up. You only have to pay for the data you send or receive, not how long you're connected.

* If you have problems getting connected, please phone Swisscom Customer Support.

Your phone contains a WAP browser used for surfing on the Mobile Internet, where you can get a lot of useful information. Normally, pages are designed for a mobile phone.

Your phone is already setup to Vodafone live! site for WAP/MMS Settings.

BROWSER BY



OPENWAVE











Viewing the WAP Browser

1. Press  during stand-by.

To Exit the WAP Browser

1. Press  to exit the browser.

Navigating a WAP Page

- : Move the highlights around in the screen.
- : Used to execute the option displayed in the lower centre of the screen.
- : Launch browser option menu.
- : Used to select an action displayed in the lower right corner of the screen.
-  (press and hold):
Used to start the Go to URL.
-  to  (press and hold):
Used to start the Bookmark (WAP).
- : Exit (short press)
Turn off the phone. (press and hold)

Browser Menu

When you have started browsing, you can reach browsing options by pressing  [Options].

The Browser menu contains the following:







- Select:
Select the link you wish to see. (“Select” is displayed only when the link is highlighted.)
- Home:
Go to the homepage you set in the WAP Settings.
- Add bookmark:
Add the site you are currently browsing to your list of bookmarks.
- View bookmarks:
See your list of bookmarks.
- Save items:
Save images or sounds or video clips to Saved Pictures, Saved Sounds or Saved Video Clips.
- Go to URL:
Input the URL of the site you wish to go to.
- History:
See your history list.

- Forward:
Move to the next URL in the history list.
- Reload page:
Refresh the contents of the WAP page.
- Advanced
 - Show URL:
Display the URL of the site you are currently browsing.
 - Save page:
Save the page you are currently browsing to your list of Snap Shots.
 - Snapshots:
See your list of Snap Shots.
 - Alert inbox:
See your list of WAP push messages. You can receive push messages via WAP Services. This means that a service provider sends WAP content to your phone, without any set up.
 - Settings:
Includes “Downloads”, etc.
 - Security:
Set the security.
 - Clear...:
Clear History, cache, etc.









- Restart browser:
Restart the browser.

Bookmarks





















To Add a Bookmark

1. Press  [Options] when you are browsing to display the Options menu.
2. Press  or  to highlight “Add bookmark”, then press  or  [Select] to select.
3. Press  to save.





















To Access Bookmarked Pages

1. Press  [Options] when you are browsing to display the Options menu.
2. Press  or  to highlight “View bookmarks”, then press  or  [Select] to select.
3. Press  or  to highlight a bookmark page you wish to access, then press  to select.

To Edit Bookmarks

1. Press  [Options] when you are browsing to display the Options menu.
2. Press  or  to highlight “View bookmarks”, then press  or  [Select] to select.
3. Press  or  to highlight “More...”, then press  to select.
4. Press  or  to highlight a bookmark page you wish to edit, then press  [Options] to display the Options menu.
5. Press  or  to highlight “Details”, then press  or  [Select] to select.
6. Edit the title, then press .
7. Edit the URL, then press .
8. Press  or  to highlight “Save”, then press  to save.

To Delete Bookmarks

1. Press  [Options] when you are browsing to display the Options menu.
2. Press  or  to highlight “View bookmarks”, then press  or  [Select] to select.
3. Press  or  to highlight “More...”, then press  to select.
4. Press  or  to highlight a bookmark page you wish to delete, then press  [Options] to display the Options menu.
5. Press  or  to highlight “Delete”, then press  or  [Select] to select.
6. Press  [Options] to display the Options menu, then press  or  to highlight “OK”, then press  or  [Select] to delete.

My Stuff (M 6)

My Stuff contains several types of picture, sound and video clip data along with applications which can be controlled collectively. Also included in My Stuff are frequently used text message phrases and accessed WAP pages (addresses) which you can use.

Games & More (M 6-1)

Along with the preloaded application, downloaded applications are stored in Applications.

Note

- *The phone can store approximately 2 Mbytes of data across Applications, Saved Pictures, Saved Sounds and Saved Video Clips. Applications can store up to 50 applications.*

Using Applications

Various kinds of Vodafone live! specific applications can be used in this phone.

To use applications, download the applications via the mobile Internet.

Some applications offer the ability to connect to a network either within a game or network based application.

Note

- *Applications may be both localised (no connectivity) and network based (using the mobile Internet to update information/play games). The network may charge you more for using network-based applications. Please contact your service provider for more information.*

Downloading Applications

Confirmation Screen













Before downloading the application you are asked to confirm what you are about to receive.

After checking the information on the confirmation screen, the application can be downloaded.







Note

- *User authentication may be required before downloading the application on some information screens.*













Download More (M 6-1-2)

1. Press  to display the Main menu.
2. Press , ,  or  to highlight “My Stuff”, then press  to select.
3. Press  or  to highlight “Games & More”, then press  to select.
4. Press  or  to highlight “Download More”, then press  to select.

The application download site is displayed.



5. Press  or  to highlight the application you wish to download.
After a WAP browser is displayed variously, the confirmation screen will appear after a whilst.
6. Press  [Options] to display the Options menu.
7. Press  or  to highlight “Get”, then press  to start.
Downloading starts.
8. Press  [OK] even if it carries out complete.

Executing Applications (M 6-1-1)





1. Press  to display the Main menu.
2. Press , ,  or  to highlight “My Stuff”, then press  to select.
3. Press  or  to highlight “Games & More”, then press  to select.
4. Press  or  to highlight “Applications”, then press  to select.

The list of Applications is displayed.





Downloaded applications are sequentially displayed from the latest one.

5. Press  or  to highlight the title of the application you wish to execute, then press  to select.
The selected application is executed.
When using network connection type applications, connection to the network can be selected.









To End the Application

1. Press .
2. Press  or  to highlight “End”, then press  to select.

To Suspend the Application









1. Press .
2. Press  or  to highlight “Suspend”, then press  to select.
To resume the application, perform steps 1 to 4 in “Executing Applications” on page 84 and highlight “Resume”, then press .

Checking the Application Information

1. Perform steps 1 to 4 in “Executing Applications” on page 84.
2. Press  or  to highlight the application you wish to check, then press  [Options].
The Options menu is displayed.
3. Press  or  to highlight “Application Details”, then press  or  [Select] to select.
The detailed information screen is displayed.
4. Press  or  to scroll through the screen.

5. When you have finished, press  [Back] twice.
The screen returns to the list.

Deleting Applications







1. Perform steps 1 to 4 in “Executing Applications” on page 84.
2. Press  or  to highlight the application you wish to delete, then press  [Options].
The Options menu is displayed.
3. Press  or  to highlight “Delete”, then press  or  [Select] to select.
4. Press  [Yes].
The selected application is deleted.
To cancel deletion, press  [No] in step 4.

Note















- *You cannot delete preloaded applications.*













Pictures (M 6-2)

Pictures that are taken by a digital camera or images that are downloaded from mobile Internet sites can be managed.







-  : Images in PNG format
-  : Pictures in JPEG format
-  : e-Animation file (NEVA)
-  : Images in GIF format
-  : Images in BMP format
-  : Images in WBMP format
-  : Images in WPNG format

Using Images as Wallpaper











1. Press  to display the Main menu.
2. Press , ,  or  to highlight “My Stuff”, then press  to select.
3. Press  or  to highlight “Pictures”, then press  to select.
4. Press  or  to highlight “Saved Pictures”, then press  to select.
The list of Saved Pictures is displayed.
5. Press  or  to highlight the file name you wish to use as wallpaper, then press  [Options].
The Options menu is displayed.

6. Press  or  to highlight “Wallpaper”, then press  or  [Select] to select.
7. Press  or  to highlight “Main Display” or “External Display”, then press  to select.
The selected picture is displayed.
8. Press , ,  or  to specify the area you wish to display, then press .









Saving to Contacts List

1. Perform steps 1 to 4 in “Using Images as Wallpaper”.
2. Press  or  to highlight the file name you wish to add to Contacts List, then press  [Options].
The Options menu is displayed.
3. Press  or  to highlight “Save to Contacts”, then press  or  [Select] to select.

When you overwrite existing Contacts List data















4. Press  or  to highlight “Existing Contact”, then press  to select.
If the picture size exceeds 240 dots [W] × 320 dots [H], press , ,  or  to specify the area you wish to display, then press .
5. Press  or  to highlight the data you wish to save to, then press .

When you save new Contacts List data

- 4 Press  or  to highlight “New Contact”, then press  to select.
If the picture size exceeds 240 dots [W] × 320 dots [H], press , ,  or  to specify the area you wish to display, then press .
For details on entering a name, see “Creating a New Entry” on page 36.

Editing Pictures















To Retouch Pictures

1. Perform steps 1 to 4 in “Using Images as Wallpaper” on page 86.
2. Press  or  to highlight the file name you wish to retouch, then press  [Options].
The Options menu is displayed.
3. Press  or  to highlight “Edit Picture”, then press  or  [Select] to select.
4. Press  or  to highlight “Retouch”, then press  to select.
5. Press  or  to highlight the retouching option you wish to use, then press  to select.
The selected option is confirmed on the display.
6. Press .

Note

- The size of pictures that can be retouched is 52 × 52 pixels minimum and 240 dots [W] × 320 dots [H] or 320 dots [W] × 240 dots [H] maximum.























To Add a Frame to Pictures

1. Perform steps 1 to 4 in “Using Images as Wallpaper” on page 86.
2. Press  or  to highlight the file name you wish to add frame to, then press  [Options].
The Options menu is displayed.
3. Press  or  to highlight “Edit Picture”, then press  or  [Select] to select.
4. Press  or  to highlight “Add Frame”, then press  to select.
5. Press  or  to highlight the frame pattern you wish to use, then press  to select.
The selected frame is confirmed on the display.
6. Press .

Note

- The size of pictures that you can add a frame to is 240 dots [W] × 320 dots [H] or 320 dots [W] × 240 dots [H] maximum.













To Add Stamps to Pictures

1. Perform steps 1 to 4 in “Using Images as Wallpaper” on page 86.
2. Press  or  to highlight the file name you wish to add stamp to, then press  [Options].
The Options menu is displayed.
3. Press  or  to highlight “Edit Picture”, then press  or  [Select] to select.
4. Press  or  to highlight “Add Stamps”, then press  to select.
5. Press  [Stamps], then press  or  to highlight the stamp pattern you wish to use, then press  to select.
6. Press , ,  or  to move the cursor to the point you wish to add a stamp.
7. Press  to add the stamp.
To add more stamps, repeat steps 5 to 7.
8. Press  [End], then press  [Yes].
To cancel, press  [No] in step 8.

Note

- The size of pictures that you can add stamps to is 24 × 24 pixels minimum and 240 dots [W] × 320 dots [H] or 320 dots [W] × 240 dots [H] maximum.



To Rotate Pictures

1. Perform steps 1 to 4 in “Using Images as Wallpaper” on page 86.
2. Press  or  to highlight the file name you wish to rotate, then press  [Options].
The Options menu is displayed.
3. Press  or  to highlight “Edit Picture”, then press  or  [Select] to select.
4. Press  or  to highlight “Rotate”, then press  to select.
The picture is rotated 90° anticlockwise.
Press  [Rotate] to rotate 90° anticlockwise.
5. Press .





Note

- *The size of pictures that you can rotate is 240 dots [W] × 320 dots [H] or 320 dots [W] × 240 dots [H] maximum.*







Downloading Picture File (M 6-2-2)



1. Perform steps 1 to 3 in “Using Images as Wallpaper” on page 86.
2. Press  or  to highlight “Download More”, then press  to select.
The picture file download site is displayed.

Viewing Pictures

1. Perform steps 1 to 4 in “Using Images as Wallpaper” on page 86.
2. Press  or  to highlight the file name you wish to view, then press  to select.
The selected picture is displayed.
3. Once you have viewed the picture, press  [Back] to return to the list.

Changing the File Name

1. Perform steps 1 to 4 in “Using Images as Wallpaper” on page 86.
2. Press  or  to highlight the file name you wish to change, then press  [Options].
The Options menu is displayed.
3. Press  or  to highlight “Rename”, then press  or  [Select] to select.

4. Enter a new file name.
To correct the last character, press  [Clear] briefly.
Press and hold  [Clear] to clear all characters.
5. Press .







Note











- *Following characters cannot be used for a file name: /, \, :, *, ?, ", <, >, | and . (full-stop).*

Adjusting the Size of the Picture

The pictures that are registered in Saved Pictures can be adjusted for use as main or external displays as well as incoming call, alarm or power on/off displays.

When the picture size is modified, the data size is updated.



















1. Perform steps 1 to 4 in “Using Images as Wallpaper” on page 86.
2. Press  or  to highlight the file name you wish to adjust, then press  [Options].
The Options menu is displayed.
3. Press  or  to highlight “Adjust Size”, then press  or  [Select] to select.

4. Press  or  to highlight “Main Display”, “External Display”, “Power On/Off”, “Incoming” or “Alarm”, then press  to select.
The selected picture is displayed.
5. Press , ,  or  to specify the area you wish to display, then press .
6. Press  to save.
To cancel registration, press  [Back] in step 6.

Note

- *“Adjust Size” may not be available depending on the original picture and copyright issued.*













Sending Messages

1. Press  to display the Main menu.
2. Press , ,  or  to highlight “My Stuff”, then press  to select.
3. Press  or  to highlight “Pictures”, then press  to select.
4. Press  or  to highlight “Saved Pictures”, then press  to select.
The list of Saved Pictures is displayed.
5. Press  or  to highlight the file name you wish to send, then press  [Options].
The Options menu is displayed.
6. Press  or  to highlight “Send Message”, then press  or  [Select] to select.
7. Enter your message.
For details on creating a message, see “Creating a New MMS” on page 59.











Note

- *Pictures with a red icon cannot be sent attached to a message.*

Deleting Pictures







1. Perform steps 1 to 4 in “Using Images as Wallpaper” on page 86.
2. Press  or  to highlight the file name you wish to delete, then press  [Options].
The Options menu is displayed.
3. Press  or  to highlight “Delete”, then press  or  [Select] to select.
4. Press  or  to highlight “One Picture” or “All Pictures”, then press  to select.
5. Press  [Yes].
To cancel deletion, Press  [No] in step 5.

Checking the Picture Information

1. Perform steps 1 to 4 in “Using Images as Wallpaper” on page 86.
2. Press  or  to highlight the file name you wish to check, then press  [Options].
The Options menu is displayed.
3. Press  or  to highlight “Picture Details”, then press  or  [Select] to select.
The detailed information screen is displayed.
4. Press  or  to scroll through the screen.
5. When you have finished, press  [Back].

Sounds (M 6-3)













The ringtones created using the Melody Editor and the AMR data recorded by Voice Memo is managed in Saved Sounds. The default ringtones are not contained within Saved Sounds.

-  : Sound file in SMAF format
-  : Original ringtone (composed in Melody Editor)
-  : Sound file in Standard MIDI format
-  : Sound file in iMelody format
-  : Sound file in WAVE format
-  : Sound file in AMR format

















Note

- *SMAF (Synthetic music Mobile Application Format) is a format of music data for mobile phones.*









Downloading Sound Files (M 6-3-2)

1. Press  to display the Main menu.
2. Press , ,  or  to highlight “My Stuff”, then press  to select.
3. Press  or  to highlight “Sounds”, then press  to select.
4. Press  or  to highlight “Download More”, then press  to select.
The sound file download site is displayed.

Playing Back Sounds











1. Press  to display the Main menu.
2. Press , ,  or  to highlight “My Stuff”, then press  to select.
3. Press  or  to highlight “Sounds”, then press  to select.
4. Press  or  to highlight “Saved Sounds”, then press  to select.
The Saved Sounds is displayed.
5. Press  or  to highlight the sound you wish to play back, then press  to select.
The selected sound is played.
To stop playing, press .

Checking the Information of the Sound Files

1. Perform steps 1 to 4 in “Playing Back Sounds”.
2. Press  or  to highlight the file name you wish to check, then press  [Options].
The Options menu is displayed.
3. Press  or  to highlight “Sound Details”, then press  or  [Select] to select.
The detailed information screen is displayed.
4. Press  or  to scroll through the screen.

5. When you have finished, press  [Back].
The screen returns to the list.

Changing the File Name

1. Perform steps 1 to 4 in “Playing Back Sounds”.
2. Press  or  to highlight the file name you wish to change, then press  [Options].
The Options menu is displayed.
3. Press  or  to highlight “Rename”, then press  or  [Select] to select.
4. Enter a new file name.
To delete the last character, press  [Clear] briefly.
Press and hold  [Clear] to clear all characters.
5. Press .

Note

- *Following characters cannot be used for a file name: /, \, :, *, ?, ", <, >, | and . (full-stop).*

Tip

- *When “Edit Data” is displayed in the menu in step 2, you are able to edit the sound (p. 112). Once you have completed editing the newly saved file overwrites the old file. This new file then becomes the original ringtone.*

Setting the Tone and Strength

1. Perform steps 1 to 4 in “Playing Back Sounds” on page 93.
2. Press or to highlight the file name you wish to edit, then press [Options].
The Options menu is displayed.
3. Press or to highlight “Set Tone” or “Set Strength”, then press or [Select] to select.
For full details, see pages 109 to 111.

Note

- If “Set Tone” and “Set Strength” are not displayed in the menu in step 2, you cannot change these settings.

Sending Messages

1. Perform steps 1 to 4 in “Playing Back Sounds” on page 93.
2. Press or to highlight the file name you wish to send, then press [Options].
The Options menu is displayed.
3. Press or to highlight “Send Message”, then press or [Select] to select.

If you select your original ringtone in step 2, perform the following, otherwise go to step 5.

4. Press or to highlight the file format “SMAF”, “MIDI” or “i Melody”, then press to select.
5. Enter your message.
For details on creating a message, see “Creating a New MMS” on page 59.

Note

- Sounds with a red icon cannot be sent attached to a message.
- Only the first part of the data is converted if you select “i Melody” in step 4.













Deleting Sounds

1. Perform steps 1 to 4 in “Playing Back Sounds” on page 93.
2. Press or to highlight the file name you wish to delete, then press [Options].
The Options menu is displayed.
3. Press or to highlight “Delete”, then press or [Select] to select.
4. Press or to highlight “One Sound” or “All Sounds”, then press to select.
5. press [Yes].
To cancel deletion, press [No] in step 5.

Video Clips (M 6-4)

















Video clips that are recorded by a video camera or video clips that are downloaded from mobile Internet sites can be managed.

Downloading Video Clip Files (M 6-4-2)

1. Press  to display the Main menu.
2. Press , ,  or  to highlight “My Stuff”, then press  to select.
3. Press  or  to highlight “Video Clips”, then press  to select.
4. Press  or  to highlight “Download More”, then press  to select.

The video clip file download site is displayed.

Playing Back Video Clip Files

1. Press  to display the Main menu.
2. Press , ,  or  to highlight “My Stuff”, then press  to select.
3. Press  or  to highlight “Video Clips”, then press  to select.
4. Press  or  to highlight “Saved Video Clips”, then press  to select.
5. Press  or  to highlight the video clip you wish to play back, then press  to select.
6. Press .

The list of Saved Video Clips is displayed.

The selected video clip is played back.

To pause playback, press .

To resume playback, press  again.

To stop playback, press  [Back].

To return to the original size, press  [×1].

Checking the Video Clip File Information

1. Perform steps 1 to 4 in “Playing Back Video Clip Files” on page 95.
2. Press or to highlight the file name you wish to check, then press [Options].
The Options menu is displayed.
3. Press or to highlight “Video Clip Details”, then press or [Select] to select.
The detailed information screen is displayed.
4. Press or to scroll through the screen.
5. When you have finished, press [Back].

Changing the File Name

1. Perform steps 1 to 4 in “Playing Back Video Clip Files” on page 95.
2. Press or to highlight the file name you wish to change, then press [Options].
The Options menu is displayed.
3. Press or to highlight “Rename”, then press or [Select] to select.
4. Enter a new file name.
To delete the last character, press [Clear] briefly.
Press and hold [Clear] to clear all characters.

5. Press .

Note

- *Following characters cannot be used for a file name: /, \, :, *, ?, ", <, >, | and . (full-stop).*













Sending Messages

1. Perform steps 1 to 4 in “Playing Back Video Clip Files” on page 95.
2. Press or to highlight the file you wish to send, then press [Options].
The Options menu is displayed.
3. Press or to highlight “Send Message”, then press or [Select] to select.
4. Enter your message.
For details on creating a message, see “Creating a New MMS” on page 59.













Note

- *Video clips with a red icon cannot be sent attached to a message.*

Deleting Video Clip files

1. Press  to display the Main menu.
2. Press , ,  or  to highlight “My Stuff”, then press  to select.
3. Press  or  to highlight “Video Clips”, then press  to select.
4. Press  or  to highlight “Saved Video Clips”, then press  to select.

The list of Saved Video Clips is displayed.

5. Press  or  to highlight the file you wish to delete, then press  [Options].
The Options menu is displayed.
6. Press  or  to highlight “Delete”, then press  or  [Select] to select.
7. Press  or  to highlight “One Video Clip” or “All Video Clips”, then press  to select.
8. Press  [Yes].
To cancel deletion, press  [No] in step 8.

Bookmarks (M 6-5)

You can store desired (or frequently used) pages (addresses) in Bookmarks. It can save your time in accessing WAP pages sites. For further details, see “Vodafone live!” on page 79.









Text Templates (M 6-6)

You can register up to 20 text templates for use in text messages and multimedia messages.





You can input messages more easily by registering frequently used text.

120 characters may be registered in any text template.

Adding Phrases to Text Templates



1. Press  to display the Main menu.
2. Press , ,  or  to highlight “My Stuff”, then press  to select.
3. Press  or  to highlight “Text Templates”, then press  to select.

The list of Text Templates is displayed.

4. Press  or  to highlight the number you wish to register, then press  to select.
5. Enter the text, then press .

For details on entering characters, see “Entering Characters” on page 29.

Editing Text Templates









1. Perform steps 1 to 3 in “Adding Phrases to Text Templates”.
2. Press  or  to highlight the number you wish to edit, then press  to select.
3. Enter new text.

To correct the last character, press  [Clear] briefly.









Press and hold  [Clear] to clear all characters.

4. Press .

Viewing Text Templates









1. Perform steps 1 to 3 in “Adding Phrases to Text Templates”.
2. Press  or  to highlight the number you wish to view, then press  [Options].
The Options menu is displayed.
3. Press  or  to highlight “View”, then press  or  [Select] to select.
The selected text template is displayed.
4. After confirmation, press  [Back] to return to the template list.

Deleting Text Templates

1. Perform steps 1 to 3 in “Adding Phrases to Text Templates” on page 98.
2. Press  or  to highlight the text template you wish to delete, then press  [Options].
3. Press  or  to highlight “Delete”, then press  or  [Select] to select.
4. Press  [Yes].
The selected text template is deleted.
To cancel deletion, press  [No] in step 4.

Memory Status (M 6-7)

This function helps you to check the memory status of My Stuff.







1. Press  to display the Main menu.
2. Press , ,  or  to highlight “My Stuff”, then press  to select.
3. Press  or  to highlight “Memory Status”, then press  to select.

Fun & Games (M 1)

Games & More (M 1-1)













Executing Applications (M 1-1-1)









You can execute games and other applications on your phone. For details about Applications, see page 84.

1. Press  to display the Main menu.
2. Press , ,  or  to highlight “Fun & Games”, then press .
3. Perform steps 3 to 5 in “Executing Applications” on page 84.

Screensavers (M 1-1-2)

You can download screensaver applications for the stand-by screen.

1. Press  to display the Main menu.
2. Press , ,  or  to highlight “Fun & Games”, then press .
3. Press  or  to highlight “Games & More”, then press .
4. Press  or  to highlight “Screensavers”, then press .







5. Press  or  to highlight “On/Off”, then press  to select.
6. Press  or  to highlight “On” to set screensavers on or “Off” to set screensavers off, then press .
7. If you select “On”, press  or  to highlight the desired application, then press .

Note

- *In the list that appears in step 7, only the available screensavers can be selected.*

Online Setting

You can set whether to connect to the network or not using the screensaver application.





1. Perform steps 1 to 4 in “Screensavers”.
2. Press  or  to highlight “Online Setting”, then press .
3. Press  or  to highlight “On” or “Off”, then press .

Note

- Changes made to the above setting whilst the application is suspended are made effective by restarting the application.
- You may not be able to make the above settings depending on your network.







Resume Time

You can set the time period for the screensaver application to activate.

1. Perform steps 1 to 4 in “Screensavers” on page 100.
2. Press  or  to highlight “Resume Time”, then press  to select.
3. Enter the resume time in two digits using the digit keys, then press .

Download More (M 1-1-3)



















You can download applications.

1. Press  to display the Main menu.
2. Press , ,  or  to highlight “Fun & Games”, then press  to select.
3. Perform steps 3 to 7 in “Download More” on page 84.



Settings (M 1-1-4)

Operation Priority

You can set the priority of incoming calls and alarms whilst an application is operating.

1. Press  to display the Main menu.
2. Press , ,  or  to highlight “Fun & Games”, then press  to select.
3. Press  or  to highlight “Games & More”, then press  to select.
4. Press  or  to highlight “Settings”, then press  to select.
5. Press  or  to highlight “Calls & Alarms”, then press  to select.
6. Press  or  to highlight the option you wish to set, then press  to select.

The options available are:

- “Incoming Call”
 - “Alarm”
7. Press  or  to highlight methods, then press  to select.

- “Call Priority” or “Alarm Priority”:
The application is suspended automatically, and you can receive a call, or the alarm will sound. After finishing the call or the alarm ends, the suspend icon (🔔) is displayed letting know there is a suspended application.
- “Call Notice” or “Alarm Notice”:
The marquee (character scrolls) is displayed on the first line of the screen whilst the application continues. If you press ⏸, the application is suspended, and you can receive a call. After finishing the call, the suspend icon (🔔) is displayed letting know there is a suspended application.

Sound Volume









You can set the volume of the application such as sound effect to one of the five levels or silent. When “Ringer Volume” (p. 125) is set to “Silent”, this setup has priority.

1. Perform steps 1 to 4 in “Operation Priority” on page 101.
2. Press ▲ or ▼ to highlight “Sound Volume”, then press ● to select.
The current volume level is displayed.
3. Press ▲ to increase the volume or press ▼ to decrease the volume, then press ● to select.

Backlight







You can select the backlight method of the application from the following three types:

- “On”: Lit whilst the application is operated.
 - “Off”: Unlit whilst the application is operated even if a key is pressed.
 - “Normal Settings”: Works with the main backlight setting. (p. 138)
1. Perform steps 1 to 4 in “Operation Priority” on page 101.

2. Press  or  to highlight “Backlight”, then press  to select.
3. Press  or  to highlight “On/Off”, then press  to select.
4. Press  or  to highlight “On”, “Off” or “Normal Settings”, then press  to select.

To Set the Blinking Operation

This setting enables the backlight to be controlled by the application. If set to “Off”, the backlight cannot be turned on from the application.

1. Perform steps 1 and 2 in “Backlight” on page 102.
2. Press  or  to highlight “Blink”, then press  to select.
3. Press  or  to highlight “On” or “Off”, then press  to select.







Vibration

When the vibrator is set in the application, you can choose whether the operation is enabled or disabled.

When a SMAF file is specified in the application, you can operate the vibrator set in the SMAF file.

Note

• *SMAF (Synthetic music Mobile Application Format) is a music data format for mobile phones.*

1. Perform steps 1 to 4 in “Operation Priority” on page 101.
2. Press  or  to highlight “Vibration”, then press  to select.
3. Press  or  to highlight “Enable”, “Disable” or “Link to Sound”, then press  to select.

When you set “Link to Sound”, the application is synchronised with the vibrator.

Online Confirmation

You can adjust the display settings of the confirmation screen of the application on application startup.

1. Perform steps 1 to 4 in “Operation Priority” on page 101.
2. Press ▲ or ▼ to highlight “Online Confirmation”, then press ● to select.
3. Press ▲ or ▼ to highlight “On”, then press ● to select.

To cancel confirmation, highlight “Off”, then press ● to select.









Reset

To Reset All Items in Settings Menu

1. Perform steps 1 to 4 in “Operation Priority” on page 101.
2. Press ▲ or ▼ to highlight “Reset”, then press ● to select.
3. Enter your handset code, then press ●.
The default handset code is “0000”. For details on changing the handset code, see “To Change Handset Code” on page 161.
If you enter a wrong handset code, the screen will return to step 4 in “Operation Priority” on page 101.
4. Press ▲ or ▼ to highlight “Settings Reset”, then press ● to select.
5. Press [Yes].
All items in Settings menu and screensaver settings are reset.
To cancel resetting, press [No] in step 5.

To Clear All Applications

All applications stored in Applications are cleared. The preloaded application cannot be deleted.

1. Perform steps 1 to 4 in “Operation Priority” on page 101.
2. Press  or  to highlight “Reset”, then press  to select.
3. Enter your handset code, then press .
If you enter a wrong handset code, the screen will return to step 4 in “Operation Priority” on page 101.
4. Press  or  to highlight “All Clear”, then press  to select.
5. Press  [Yes].
All applications are cleared.
To cancel clearing, press  [No] in step 5.

Java™ Information (M 1-1-5)

The information about the license belonging to Java™ can be displayed.













Melody Editor (M 1-2)



You can create an original ringtone, or you can send a melody attached to a multimedia message.

You can input up to 190 tones × 16 voices, or 380 tones × 8 voices per melody.





The original ringtone is registered in Saved Sounds.

Creating Your Original Ringtone (M 1-2-1)





1. Press  to display the Main menu.
2. Press , ,  or  to highlight “Fun & Games”, then press  to select.
3. Press  or  to highlight “Melody Editor”, then press  to select.
4. Press  or  to highlight “Create New”, then press  to select.
5. Enter the title.
Up to 24 characters can be entered.
For details on entering characters, see “Entering Characters” on page 29.
6. Press .

7. Press  or  to highlight a tempo, then press  to select.

The music tempo is described below.

- “Allegro (Fast)”:  150
- “Moderato (Normal)”:  125
- “Andante (Slow)”:  107
- “Adagio (Very Slow)”:  94

Tempo is defined by the number of crotchets () played per minute.

8. Press  or  to highlight “8 Chords” or “16 Chords”, then press  to select.
9. Press the digit keys to specify the musical scale and rest.
10. Press  or  to specify the types of musical notes or rest.

For details on specifying the sound level and rest, see “To Specify the Musical Scale and Rest” on page 107.

For details on specifying the musical notes and rest, “To Specify the Types of Notes and Rests” on page 108.

11. Press  after inputting one note.









Input the next note after the cursor moves to the right.

12. Repeat steps 9 to 11 to input notes.

When you press  during input, the melody that you have entered is played back.

When you press  [Options] and select “Play before Cursor” whilst entering notes, the melody, that is displayed on the screen, is played back up to the cursor position.

When you press  [Options] and select “Select Chord”, you can select another chord. Repeat steps 9 to 11 to input notes for the new chord.

13. When you finish inputting, press  [Options] to display the Options menu.
14. Press  or  to highlight “Save”, then press  or  [Select] to select.
15. Press  or  to highlight “Save to My Stuff”, then press  to select.
- Your original ringtone is registered in Saved Sounds.

Note

- If the capacity or memory in Saved Sounds becomes insufficient, the message, "Maximum capacity : 250 Not registered." or "Not registered. Memory full." is displayed. The display returns to the screen of step 15. Try again after deleting unnecessary data (p. 94).

To Specify the Musical Scale and Rest

Using the keys shown below, specify the musical scale and rest.

Do	Re	Mi	Fa	Sol	La	Ti	Rest
1 <small>OD</small>	2 <small>ABC</small>	3 <small>DEF</small>	4 <small>G#B</small>	5 <small>JL</small>	6 <small>MNO</small>	7 <small>PQRS</small>	0 <small>_</small>

When you press the key shown above once, a crotchet is specified in the middle scale (no mark).



When you press the same key repeatedly, the note will shift cycle through the available octave ranges.



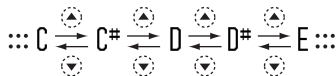

When you press \triangle or ∇ whilst a note is selected, the note will move one semitone higher or lower.

When entering rest: Crotchet rest is entered.

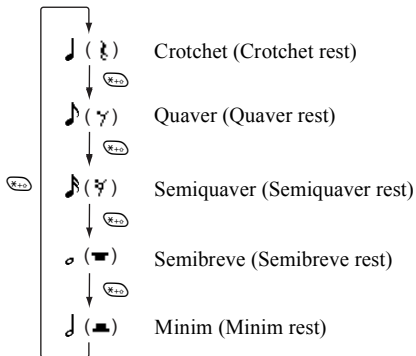

To Specify the Types of Notes and Rests
Specify notes and rests by pressing  or  repeatedly.



When you make a dotted note or a triplet, press  after selecting the target note.

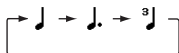



Note

- You cannot make a dotted semiquaver (semiquaver rest) or a dotted semibreve (semibreve rest).
- Three continuous notes are required for a triplet.

To specify a tie, press  after selecting the target notes.

An underscore () is displayed next to the note, and the note is tied with the next one.

To enter the next note, press  and move the cursor to the right. Then, repeat the operation on the previous page.

If the cursor is positioned next to a note, you can repeat the note immediately left of the cursor when  or  is pressed.

To Set the Tone

The phone can play notes using different instruments.

1. Perform steps 1 to 13 in “Creating Your Original Ringtone” on page 105.
2. Press ▲ or ▼ to highlight “Set Tone”, then press ● to select.
3. Press ◀ or ▶ to highlight a category of the tone.
4. Press ▲ or ▼ to highlight a tone.

When you press Ⓞ [Options] and select “Play Current Chord”, the melody entered is played back in the selected tone.

When you press Ⓞ [Options] and select “Confirm Tones”, the syllable names are played back in the selected tone.

5. Press ●.

Now you can create a melody.

You can select from the following 128 tones.

Category	Tone	Category	Tone
Pianos	Piano Bright Piano E. Grand Piano Honky-tonk Electric Piano 1 Electric Piano 2 Harpichord Clavi	Chimes	Celesta Glockenspiel Music Box Vibraphone Marimba Xylophone Tubular Bells Dulcimer
Organs	Drawbar Organ Percussive Organ Rock Organ Church Organ Reed Organ Accordion Harmonica Tango Accordion	Guitars	Nylon Guitar Steel Guitar Jazz Guitar Clean Guitar Muted Guitar Overdriven Guitar Distortion Guitar Guitar Harmonics
Basses	Acoustic Bass Finger Bass Pick Bass Fretless Bass Slap Bass 1 Slap Bass 2 Synth Bass 1 Synth Bass 2	Strings 1	Violin Viola Cello Contrabass Tremolo Strings Pizzicato Strings Harp Timpani

Category	Tone	Category	Tone
Strings 2	String Ensemble 1 String Ensemble 2 Synth Strings 1 Synth Strings 2 Choir Aahs Voice Oohs Synth Voice Orchestra Hit	Brasses	Trumpet Trombone Tuba Muted Trumpet French Horn Brass Section Synth Brass 1 Synth Brass 2
Reeds	Soprano Sax Alto Sax Tenor Sax Baritone Sax Oboe English Horn Bassoon Clarinet	Flutes/ Pipes	Piccolo Flute Recorder Pan Flute Blown Bottle Shakuhachi Whistle Ocarina
Synth Leads	Square Lead Sawtooth Lead Calliope Lead Chiff Lead Charang Lead Voice Lead Fifth Lead Bass & Lead	Synth Pads	New Age Pad Warm Pad Polysynth Pad Choir Pad Bowed Pad Metallic Pad Halo Pad Sweep Pad

Category	Tone	Category	Tone
Synth Effects	Rain Soundtrack Crystal Atmosphere Brightness Goblins Echoes Science Fiction	Ethnics	Sitar Banjo Shamisen Koto Kalimba Bagpipe Fiddle Shanai
Percussions	Tinkle Bell Agogo Steel Drums Woodblock Taiko Drums Melodic Tom Synth Drum Reverse Cymbal	Effects	Gtr. Fret Noise Breath Noise Seashore Bird Tweet Telephone Ring Helicopter Applause Gunshot

To Set the Strength of the Original Ringtone

The strength of the original ringtone can be set in 3 levels for each melody.





























When you purchase this phone, the strength of the original ringtone is set to “Loud”.

1. Perform steps 1 to 13 in “Creating Your Original Ringtone” on page 105.
2. Press ▲ or ▼ to highlight “Set Strength”, then press ●.
3. Press ▲ or ▼ to highlight a strength of the tone. When [Play] is pressed, the original ringtone entered is played back in the selected strength of the tone.
4. Press ●.
Now you can create an original ringtone.

Deleting an Original Ringtone











1. Perform steps 1 to 4 in “Playing Back Sounds” on page 93.
2. Press ▲ or ▼ to highlight the file name you wish to delete, then press [Options].
The Options menu is displayed.
3. Press ▲ or ▼ to highlight “Delete”, then press ● or [Select] to select.
4. Press ▲ or ▼ to highlight “One Sound” or “All Sounds”, then press ● to select.
5. press [Yes].
To cancel deletion, press [No] in step 5.

Editing Original Ringtones

1. Press  to display the Main menu.
2. Press , ,  or  to highlight “Fun & Games”, then press  to select.
3. Press  or  to highlight “Melody Editor”, then press  to select.
4. Press  or  to highlight “Existing Melodies”, then press  to select.
5. Press  or  to highlight an original ringtone you wish to edit, then press  [Options].
The Options menu is displayed.
6. Press  or  to highlight “Edit Data”, then press  or  [Select] to select.
7. Edit the title, then press .
8. Press  or  to highlight a tempo, then press  to select.
9. Press  or  to highlight the number of voices, then press  to select.
10. Press  or  to highlight a note you wish to change, then edit notes.
When you add notes, enter the note correctly on the cursor.

To delete a note, press  [Clear] briefly.



Press and hold  [Clear] to clear all tones.

11. When you finish editing, press  [Options] to display the Options menu.
12. Press  or  to highlight “Save”, then press  or  [Select] to select.
13. Press  or  to highlight “Save to My Stuff”, then press  to select.
14. Press  or  to highlight “Overwrite”, then press  to select.
The original ringtone is changed.
If you select “New”, the melody before the correction is not modified. The original ringtone is registered as a new original ringtone.

Note

- When the number of voices is modified in step 9, the confirmation screen may be displayed. When you press  [Yes], a section of the melody may be deleted.
- When you are going to add notes in step 10, you cannot add any notes if you have already entered 380 notes (for 8 voices melodies) or 190 notes (for 16 voices melodies).





Tip















- To delete the continuous melody, press  [Options] and then press  or  [Select] after selecting “Delete after Cursor” or “Delete before Cursor”. You can delete the melody after the cursor or before the cursor.

Copying and Pasting Notes

You can copy and move a part of the melody to another position.

Only original ringtones or editable melodies can be copied or moved.

1. Perform steps 1 to 9 in “Editing Original Ringtones” on page 112.
2. Press  [Options] to display the Options menu.
3. Press  or  to highlight “Copy” or “Cut”, then press  or  [Select] to select.

4. Press  or  to move the cursor to the first note to be copied or to be cut, then press .
5. Press  or  to move the cursor to the last note to highlight the area, then press .
The highlighted area is saved temporarily in the memory. If you select “Cut” in step 3, the highlighted area is cut.
6. Press  [Options] to display the Options menu.
7. Press  or  to highlight “Paste”, then press  or  [Select] to select.
8. Press  or  to move the cursor to the point you wish to paste the notes, then press .
Saved notes are pasted.









Applications (M 3)

SIM Application (M 3-1)









You can refer to the information on the SIM. Contact your service provider for further details.

Calendar (M 3-2)

The Calendar function helps you organise and manage your busy schedule. You can view the stored schedule on a monthly basis.

1. Press  to display the Main menu.
2. Press , ,  or  to highlight “Applications”, then press  to select.
3. Press  or  to highlight “Calendar”, then press  to select.

The current month is displayed and the current date is highlighted.

4. Press , ,  or  to highlight the day for the schedule, then press  to select.
5. Press  or  to highlight the note number, then press  to select.
6. Enter the schedule content, then press .
Up to 3 schedule items can be stored.

For details on entering characters, see “Entering Characters” on page 29.

If you wish to add another item, repeat steps 5 and 6.







7. When you have finished entering, press  [Back].
The screen returns to the calendar. Dates with scheduled tasks/meetings are underlined.

Note

- *The calendar can be displayed for dates from January 2000 through to December 2099.*









To Find a Particular Date

You can move the view to a specified date in the calendar.

1. Press  [Options] to display the Options menu.
2. Press  or  to highlight “Go to Date”, then press  or  [Select] to select.
3. Enter the date of the calendar to be displayed, then press .
The specified date is displayed.













To Change to Weekly Format



You can change the Calendar to weekly format.

1. Perform steps 1 to 3 in “Calendar” on page 114.
The current month is displayed and the current date is highlighted.
2. Press  [Options] to display the Options menu.
3. Press  or  to highlight “Weekly Format”, then press  or  [Select] to select.
4. Press  or  to highlight “Monday-Sunday” to display weekly format from Monday or “Sunday-Saturday” to display weekly format from Sunday, then press  to select.

Deleting Schedules

To Delete Schedule Items













1. Perform steps 1 to 3 in “Calendar” on page 114.
2. Press , ,  or  to highlight the day, then press  to select.
3. Press  or  to highlight the item you wish to delete, then press  [Options].
The Options menu is displayed.
4. Press  or  to highlight “Delete”, then press  or  [Select] to select.

5. Press  or  to highlight “1 data”, then press  to select.

6. Press  [Yes].











To cancel deleting, press  [No] in step 6.

To Delete All Scheduled Tasks/Meetings for a Specific Day

1. Perform steps 1 to 3 in “Calendar” on page 114.
2. Press , ,  or  to highlight the day you wish to delete, then press  [Options].
The Options menu is displayed.
3. Press  or  to highlight “Delete”, then press  or  [Select] to select.
4. Press  or  to highlight “1 day” to delete all contents for a day, then press  to select.
5. Press  [Yes].

To cancel deletion, press  [No] in step 5.

To Delete All Scheduled Entries

1. Perform steps 1 to 3 in “Calendar” on page 114.
2. Press  [Options] to display the Options menu.
3. Press  or  to highlight “Delete” to delete all scheduled entries, then press  or  [Select] to select.
4. Press  or  to highlight “All Data” to delete all scheduled entries, then press  to select.
5. Press  [Yes].
To cancel deletion, press  [No] in step 5.



















Alarm (M 3-3)

Setting the Alarm (M 3-3-1)

The alarm function allows you to be alerted at a specified time.

Note that the alarm may not function correctly if the clock has not been set.

The alarm functions only if the phone is switched on.

1. Press  to display the Main menu.
2. Press , ,  or  to highlight “Applications”, then press  to select.
3. Press  or  to highlight “Alarm”, then press  to select.
4. Press  or  to highlight “List Alarms”, then press  to select.
5. Press  or  to highlight the desired alarm number, then press  to select.
Up to 5 alarm times can be specified.
6. Press  or  to highlight “Set Time”, then press  to select.
7. Enter the alarm time using the digit keys, then press .

When you enter the alarm time in the 12-hour clock format, press  to switch between am and pm.

8. Press ▲ or ▼ to highlight “Repeat Daily”, then press ● to select.
9. Press ▲ or ▼ to highlight “On” or “Off”, then press ● to select.
10. Press ▲ or ▼ to highlight “Alarm Status”, then press ● to select.
11. Press ▲ or ▼ to highlight “On”, then press ● to select.
12. Press [Save].

To Change the Type of Alarm Tone

1. Perform steps 1 to 5 in “Setting the Alarm” on page 116.
2. Press ▲ or ▼ to highlight “Alarm Tone”, then press ● to select.
3. Press ▲ or ▼ to highlight “Tone”, then press ● to select.
4. Press ▲ or ▼ to highlight “Preset Melodies” or “My Sounds”, then press ● to select.
5. Press ▲ or ▼ to highlight the alarm tone.
If you wish to hear the demo play, press [Play].
To stop playing, press [Stop].
6. When selection is complete, press ●.

To Change the Vibration of the Alarm

1. Perform steps 1 to 5 in “Setting the Alarm” on page 116.
2. Press ▲ or ▼ to highlight “Alarm Tone”, then press ● to select.
3. Press ▲ or ▼ to highlight “Vibration”, then press ● to select.
4. Press ▲ or ▼ to highlight “Enable”, “Disable” or “Link to Sound”, then press ● to select.

To Change the Duration of the Alarm

1. Perform steps 1 to 5 in “Setting the Alarm” on page 116.
2. Press ▲ or ▼ to highlight “Alarm Tone”, then press ● to select.
3. Press ▲ or ▼ to highlight “Duration”, then press ● to select.

The current duration is displayed.

4. Enter the length of the duration in 2 digits (02 to 59 seconds) using the digit keys, then press ●.









Changing Alarm Settings

1. Perform steps 1 to 4 in “Setting the Alarm” on page 116.
2. Press ▲ or ▼ to highlight the number you wish to change, then press ● to select.
3. Change Alarm settings.
For details on changing Alarm settings, see “Setting the Alarm” on page 116.





Disabling the Alarm Function

1. Perform steps 1 to 5 in “Setting the Alarm” on page 116.
2. Press ▲ or ▼ to highlight “Alarm Status”, then press ● to select.
3. Press ▲ or ▼ to highlight “Off”, then press ● to select.
4. Press [Save].

Resetting an Alarm Setting













1. Perform steps 1 to 4 in “Setting the Alarm” on page 116.
2. Press  or  to highlight the number you wish to reset, then press  to select.
3. Press  or  to highlight “Reset Alarm”, then press  to select.
4. Press  [Yes].
To cancel resetting, press  [No] in step 4.

Resetting All Alarm Settings

1. Perform steps 1 to 3 in “Setting the Alarm” on page 116.
2. Press  or  to highlight “Clear All”, then press  to select.
3. Press  [Yes].
To cancel resetting, press  [No] in step 3.

Calculator (M 3-4)

The calculator function performs the 4 arithmetic calculations using up to 12 digits.

1. Press  to display the Main menu.
2. Press , ,  or  to highlight “Applications”, then press  to select.
3. Press  or  to highlight “Calculator”, then press  to select.
4. Press  or  to highlight “Calculator”, then press  to select.
The calculator is displayed on the display.
5. Key operations for calculation are as follows.



To enter a decimal point, press .

To clear the entered number or operand, press  [Clear].









To do the calculations, press .

- If you wish to start a new calculation, press  [Clear].





Rate Conversion

You can also use the calculator as a currency calculator to convert from/to a home currency using a conversion rate that you enter.

To Set a Currency Conversion Rate

- Perform steps 1 to 3 in “Calculator” on page 119.
- Press  or  to highlight “Exchange Rate”, then press  to select.
- Press  or  to highlight “Foreign \rightarrow Domestic” or “Domestic \rightarrow Foreign”, then press  to select.
- Enter the currency conversion rate, then press .
To delete all digits, press  [Clear].

To Convert a Value

- Perform steps 1 to 4 in “Calculator” on page 119.
- Enter the value to be converted, then press  [Options].
The Options menu is displayed.
- Press  or  to highlight “In Domestic” or “In Foreign”, then press  or  [Select] to select.
The result is displayed.
If you select “Exchange Rate” in step 3, you can set a currency conversion rate.















Note

- You cannot perform step 2 when an arithmetic symbol (+, -, \times or \div) is displayed.



Voice Memo (M 3-5)

This allows you to record a voice message of up to 10 seconds, which can be used to remind you of schedule entries or be sent within a multimedia message. The recorded voice memo is registered in Saved Sounds.





To Record a Voice Memo

1. Press  to display the Main menu.
2. Press , ,  or  to highlight “Applications”, then press  to select.
3. Press  or  to highlight “Voice Memo”, then press  to select.
4. Press  to start recording.
To stop recording before the recording time is over, press .
5. Press  or  to highlight “Save” to save the voice memo, then press  to select.

Tip

- You can also record a voice memo by pressing  during stand-by, then press  whilst the Main menu is displayed, instead of steps 1 to 3.
- If you wish to record a voice memo again, press  [Cancel] in step 5. The screen will return to step 4.

To Play Back the Saved Voice Memo













1. Perform steps 1 to 4 in “To Record a Voice Memo”.
2. Press  or  to highlight “Playback”, then press  to select.
3. Press .

The recorded voice memo is played back.

To stop playback, press .













PC Link (M 3-6)

You can connect your phone to a PC using either the infrared link or the cable connection. PC software is necessary for a PC connection. For details on how to get the link software and the functions, see page 167.

1. Press  to display the Main menu.
2. Press , ,  or  to highlight “Applications”, then  to select.
3. Press  or  to highlight “PC Link”, then press  to select.
4. Press  or  to highlight “Data Cable” for cable connection or “Infrared” for infrared link, then press  to select.

Phone Help (M 3-7)

You can view the help list and use it to guide you in the phone’s functions.

1. Press  to display the Main menu.
2. Press , ,  or  to highlight “Applications”, then press  to select.
3. Press  or  to highlight “Phone Help”, then press  to select.
The help list is displayed.
4. Press  or  to highlight the desired function.
5. When you have finished, press  [Back].

Profiles (M 7)









You can easily alter the phone tone (e.g. the ringer volume, keypad tones, etc.) according to your environment.

Tone sound and vibration set can be customised for each profile.





There are 5 profiles including one user definable profile:

- Normal
- Meeting
- Activity
- Car
- Silent

Activating a Profile

1. Press  to display the Main menu.
2. Press , ,  or  to highlight “Profiles”, then press  to select.
The Profiles screen is displayed.
3. Press  or  to highlight the profile you wish to activate, then press  to select.

















Note

- When a profile is set, the icon which corresponds to the profile name is displayed in the stand-by screen:
 -  **Normal:** Is the default setup. (not displayed in the stand-by screen)
 -  **Meeting:** For use when discretion is needed.
 -  **Activity:** For use in busy environments.
 -  **Car:** For use in the car. (connected to a hands free car kit)
 -  **Silent:** For use when silence is needed. All sounds are muted and you are alerted to calls with the vibrator.











Tip

- You can press and hold  for approximately 2 seconds instead of steps 1 and 2 to display the Profiles screen during stand-by.

Customising Profiles

1. Press  to display the Main menu.
2. Press , ,  or  to highlight “Profiles”, then press  to select.
3. Press  or  to highlight the profile you wish to customise, then press  [Options].
4. Press  or  to highlight “Personalise”, then press  or  [Select] to select.
5. Press  or  to highlight the setting you wish to customise, then press  to select.
6. Change the desired setting.
For details about settings, see pages 125 to 129.
7. When you have finished, press  [Save] to save the modifications.

Resetting Profile Settings

1. Perform steps 1 and 2 in “Customising Profiles”.
2. Press  or  to highlight the profile you wish to reset, then press  [Options].
3. Press  or  to highlight “Set to Default”, then press  or  [Select] to select.
4. Enter your handset code, then press .
5. Press  [Yes].
To cancel the resetting, press  [No] in step 5.

Note

- *If you enter a wrong handset code in step 4, the screen returns to step 3.*

Ringer Volume

You can adjust the ringer volume to one of 6 levels or a step tone.

When it is set to “Silent”, the volume of applications is muted.

1. Perform steps 1 to 4 in “Customising Profiles” on page 124.
2. Press ▲ or ▼ to highlight “Ringer Volume”, then press ● to select.
The current volume level is displayed.
3. Press ▲ to increase the ringer volume or press ▼ to decrease the ringer volume and then press ●.
To select “Step Tone”, press ▲ at level 5.
To select “Silent”, press ▼ at level 1.

Assigning Melody

You can select the ringtone from 28 tones including 5 patterns, 13 sound effects and 10 melodies. You can also select a sound in Saved Sounds as the default ringtone excluding the AMR/WAVE format.







1. Perform steps 1 to 4 in “Customising Profiles” on page 124.
2. Press ▲ or ▼ to highlight “Assign Melody”, then press ● to select.
3. Press ▲ or ▼ to highlight “Preset Melodies” or “My Sounds”, then press ● to select.
4. Press ▲ or ▼ to highlight the ringtone you wish to use.
If you wish to hear the demo, press [Play].
To stop playing, press [Stop].
5. When selection is complete, press ●.

Note

- If you delete a ringtone that uses a sound in Saved Sounds, the default ringtone is set.

Vibration

When the vibrator option is set on, the phone will vibrate for incoming calls regardless of the ringer volume and tone settings.



















1. Perform steps 1 to 4 in “Customising Profiles” on page 124.
2. Press  or  to highlight “Vibration”, then press  to select.
3. Press  or  to highlight “Enable”, “Disable” or “Link to Sound”, then press  to select.

Tip

- When “Link to Sound” is selected in step 3, melodies are synchronised with the vibrator for the ringtone. However, this function may not work depending on the data.
- When you select “Enable” or “Link to Sound” in step 3, “” is displayed on the stand-by screen.

Keypad Tones

When the keypad tone is set on, you will hear a confirmation tone each time you press any keys.

1. Perform steps 1 to 4 in “Customising Profiles” on page 124.
2. Press  or  to highlight “Keypad Tones”, then press  to select.
3. Press  or  to highlight “On” or “Off”, then press  to select.
If you select “Off”, the screen returns to step 1.
4. Press  or  to highlight “Volume”, then press  to select.
5. Press  to increase the volume or press  to decrease the volume, then press .
6. Press  or  to highlight “Tone”, then press  to select.
7. Press  or  to highlight either “Preset Melodies”, “My Sounds” or “Default Tone”, then press  to select.

If you select “Preset Melodies” or “My Sounds” in step 7, perform the following, otherwise go to step 9.

8. Select the keypad tone.
For details on selecting a ringtone, see “Assigning Melody” on page 125.
9. Press ▲ or ▼ to highlight “Duration”, then press ● to select.
10. Press ▲ or ▼ to highlight the desired duration, then press ● to select.

Warning Tone

This function enables your phone to emit the warning tone when an error occurs.

1. Perform steps 1 to 4 in “Customising Profiles” on page 124.
2. Press ▲ or ▼ to highlight “Warning Tone”, then press ● to select.
3. Press ▲ or ▼ to highlight “On” or “Off”, then press ● to select.
If you select “Off”, the screen returns to step 1.
4. Press ▲ or ▼ to highlight “Volume”, then press ● to select.
5. Press ▲ to increase the volume or press ▼ to decrease the volume, then press ●.

6. Press ▲ or ▼ to highlight “Tone”, then press ● to select.
7. Press ▲ or ▼ to highlight “Preset Melodies” or “My Sounds”, then press ● to select.
8. Select the warning tone.
For details on selecting a ringtone, see “Assigning Melody” on page 125.
9. Press ▲ or ▼ to highlight “Duration”, then press ● to select.
10. Press ▲ or ▼ to highlight the duration, then press ● to select.

Power On/Off Sound

The phone can be set up to emit a sound when it is switched on or off. You can define the volume, duration and the melody to be used for this task.

1. Perform steps 1 to 4 in “Customising Profiles” on page 124.
2. Press ▲ or ▼ to highlight “Power On Sound” or “Power Off Sound”, then press ● to select.
3. Press ▲ or ▼ to highlight “On” or “Off”, then press ● to select.

If you select “Off”, the screen returns to step 1.

4. Press ▲ or ▼ to highlight “Volume”, then press ● to select.
5. Press ▲ to increase the volume or press ▼ to decrease the volume and then press ●.
6. Press ▲ or ▼ to highlight “Sound”, then press ● to select.
7. Press ▲ or ▼ to highlight “Preset Melodies” or “My Sounds”, then press ● to select.
8. Select the ringtone.











For details on selecting a ringtone, see “Assigning Melody” on page 125.

9. Press ▲ or ▼ to highlight “Duration”, then press ● to select.
10. Enter the desired duration of the ringtone in 2 digits (01 to 10 seconds) using the digit keys, then press ●.

Message Alert







When receiving messages, special ringtones can be set.

1. Perform steps 1 to 4 in “Customising Profiles” on page 124.
2. Press ▲ or ▼ to highlight “Message Alert”, then press ● to select.
3. Press ▲ or ▼ to highlight “Multimedia”, “Text” or “WAP”, then press ● to select.
4. Press ▲ or ▼ to highlight “Volume”, then press ● to select.
5. Press ▲ to increase the volume or press ▼ to decrease the volume and then press ●.
6. Press ▲ or ▼ to highlight “Sound”, then press ● to select.
7. Press ▲ or ▼ to highlight “Preset Melodies” or “My Sounds”, then press ● to select.





8. Select the ringtone.
For details on selecting a ringtone, see “Assigning Melody” on page 125.
9. Press  or  to highlight “Vibration”, then press  to select.
10. Press  or  to highlight “Enable”, “Disable” or “Link to Sound”, then press  to select.
11. Press  or  to highlight “Duration”, then press  to select.
12. Enter the duration of ringtone in 2 digits (01 to 15 seconds) using the digit keys, then press .







Low Battery Alert

Adjust the volume of the alarm when the battery becomes low.

1. Perform steps 1 to 4 in “Customising Profiles” on page 124.
2. Press  or  to highlight “Low Battery Alert”, then press  to select.
3. Press  to increase the volume or press  to decrease the volume and then press .

Any Key Answer

You can also answer a call by pressing any key except ,  [Busy],  and . For details, see page 23.















1. Perform steps 1 to 4 in “Customising Profiles” on page 124.
2. Press  or  to highlight “Any Key Answer”, then press  to select.
3. Press  or  to highlight “On” or “Off”, then press  to select.

Contacts (M 8)

Call Log (M 8-2)

The phone will record the last 10 missed calls, received calls and dialled numbers.

Viewing Call Log

1. Press  to display the Main menu.
2. Press , ,  or  to highlight “Contacts”, then press  to select.
3. Press  or  to highlight “Call Log”, then press  to select.
4. Press  or  to highlight “Missed Calls”, “Received Calls” or “Dialled Numbers”, then press  to select.
5. Press  or  to highlight the number you wish to view.
6. Press .





Call log “1” is the most recent.

When you press , call log “2” is displayed.











If you wish to dial the number, press .

7. When you have finished, press  [Back] to return to step 4.

Tip

- You can also confirm call logs by pressing  during stand-by mode.
- You can switch between histories by pressing  or  in step 5 only when you enter by  in stand-by mode.

Sending Messages

1. Perform steps 1 to 5 in “Viewing Call Log”.
2. Press  or  to highlight the call log you wish to send, then press  to select.
The selected call record is displayed in detail.
3. Press  [Options] to display the Options menu.
4. Press  or  to highlight “Send Message”, then press  or  [Select] to select.
5. Press  or  to highlight “Multimedia” or “Text”, then press .
6. Enter your message.

For details on creating a message, see “Creating a New MMS” on page 59 or “Creating a New SMS” on page 70.

Deleting a Call Log

To Delete a Single Call Log

1. Perform steps 1 to 5 in “Viewing Call Log” on page 130.
2. Press ▲ or ▼ to highlight the call log you wish to delete, then press ● to select.

The selected call log is displayed in detail.

3. Press ⏻ [Options] to display the Options menu.
4. Press ▲ or ▼ to highlight “Delete”, then press ● or ⏻ [Select] to select.
5. Press ⏻ [Yes].

The selected call log is deleted.

To cancel deletion, press ⏻ [No] in step 5.

Call Timers (M 8-2-4)

This function lets you check the duration of your calls.

Checking the Duration of the Last Call

1. Press ● to display the Main menu.
2. Press ▲, ▼, ⏪ or ⏩ to highlight “Contacts”, then press ● to select.
3. Press ▲ or ▼ to highlight “Call Log”, then press ● to select.
4. Press ▲ or ▼ to highlight “Call Timers”, then press ● to select.
5. Press ▲ or ▼ to highlight “Last Call”, then press ● to select.







The duration of the last call is now displayed.

6. When you have finished, press ⏻ [Back] to return to call timers menu.

Checking the Total Call Time

1. Press ▲ or ▼ to highlight “All Calls”, then press ● to select in step 5 in “Checking the Duration of the Last Call”.
2. When you have finished, press ⏻ [Back].

















Resetting All Call Timers

1. Perform steps 1 to 4 in “Checking the Duration of the Last Call” on page 131.
2. Press  or  to highlight “Clear Timers”, then press  to select.
3. Enter your handset code, then press .
4. Press  [Yes].
The Call Timers are reset to zero.
To cancel resetting, press  [No] in step 4.

Call Costs (M 8-2-5)

This function lets you check the charges for your calls. Some networks do not support Charging Advice. Please check with your service provider for availability.

Checking the Cost of the Last Call

1. Press  to display the Main menu.
2. Press , ,  or  to highlight “Contacts”, then press  to select.
3. Press  or  to highlight “Call Log”, then press  to select.
4. Press  or  to highlight “Call Costs”, then press  to select.
5. Press  or  to highlight “Last Call”, then press  to select.
The cost of the last call is now displayed.
6. When you have finished, press  [Back] to return to call costs menu.

Checking the Total Call Cost

1. Press ▲ or ▼ to highlight “All Calls” in step 5 in “Checking the Cost of the Last Call” on page 132, then press ● to select.
2. When you have finished, press ⏪ [Back].

Setting the Charge Rate

Set the charge rate to calculate the call cost and set the maximum limit for call cost.

1. Perform steps 1 to 4 in “Checking the Cost of the Last Call” on page 132.
2. Press ▲ or ▼ to highlight “Cost Units”, then press ● to select.
3. Press ▲ or ▼ to highlight “Set Units”, then press ● to select.
4. Enter your PIN2 code, then press ●.
5. Enter a cost per unit, then press ●.
To enter a decimal point, press $\frac{\square}{\square}$.
6. Enter a currency unit (up to 3 characters), then press ●.

Checking the Charge Rate

1. Press ▲ or ▼ to highlight “Read Units”, then press ● to select in step 3 in “Setting the Charge Rate”.
The charge rate is now displayed.
2. When you have finished, press ⏪ [Back].

Setting the Charge Limit

This function is useful if you wish to make sure you do not exceed a certain charge limit.

1. Perform steps 1 to 4 in “Checking the Cost of the Last Call” on page 132.
2. Press ▲ or ▼ to highlight “Max Cost”, then press ● to select.
3. Press ▲ or ▼ to highlight “Set Limit”, then press ● to select.
4. Enter your PIN2 code, then press ●.
5. Enter a value, then press ●.
To enter a decimal point, press $\frac{\square}{\square}$.

Checking the Charge Limit

1. Press ▲ or ▼ to highlight “Read Limit”, then press ● to select in step 3 in “Setting the Charge Limit” on page 133.
The value of the charge limit is displayed.
2. When you have finished, press ⏪ [Back].

Resetting All Call Costs

1. Perform steps 1 to 4 in “Checking the Cost of the Last Call” on page 132.
2. Press ▲ or ▼ to highlight “Clear Costs”, then press ● to select.
3. Enter your PIN2 code, then press ●.
4. Press ⏩ [Yes].
The Call Costs are reset to zero.
To cancel resetting, press ⏪ [No] in step 4.

Checking the Residual Credit

1. Perform steps 1 to 4 in “Checking the Cost of the Last Call” on page 132.
2. Press ▲ or ▼ to highlight “Residual Credit”, then press ● to select.
3. When you have finished, press ⏪ [Back].

Data Counter (M 8-2-6)

You can confirm the amount of bytes which you used in the GPRS transmission.









1. Press ● to display the Main menu.
2. Press ▲, ▼, ⏪ or ⏩ to highlight “Contacts”, then press ● to select.
3. Press ▲ or ▼ to highlight “Call Log”, then press ● to select.
4. Press ▲ or ▼ to highlight “Data Counter”, then press ● to select.
5. Press ▲ or ▼ to highlight “Last Data” or “All Data”, then press ● to select.
You can now check the amount of bytes.
6. When you have finished, press ⏪ [Back].

Resetting All Data Counter

1. Perform steps 1 to 4 in “Data Counter”.
2. Press ▲ or ▼ to highlight “Clear Counter”, then press ● to select.
3. Press ⏩ [Yes].
The Data Counter is reset to zero.
To cancel resetting, press ⏪ [No] in step 3.











Speed Dial List (M 8-3)

You can view and perform other operations for phone numbers registered in the Speed Dial List.

1. Press  to display the Main menu.
2. Press , ,  or  to highlight “Contacts”, then press  to select.
3. Press  or  to highlight “Speed Dial List”, then press  to select.

The names and phone numbers stored in the Speed Dial List are displayed in order.

Registering the Phone Numbers in the Speed Dial List













1. Perform steps 1 to 3 in “Speed Dial List”.
2. Press  or  to highlight the phone number you wish to register in the Speed Dial List.
3. Press  [Options] to display the Options menu.
4. Press  or  to highlight “Assign” (or “Re-assign”), then press  or  [Select] to select.
5. Press  or  to highlight the name you wish to register in the Speed Dial List, then press .

Tip

- You can select other options in step 4:
“Delete”: Deletes the selected entry.
“Clear All”: Deletes all registered entries.

My Numbers (M 8-4)

You can check your own voice, data and fax phone numbers.

1. Press  to display the Main menu.
2. Press , ,  or  to highlight “Contacts”, then press  to select.
3. Press  or  to highlight “My Numbers”, then press  to select.
4. Press  or  to highlight the phone number you wish to check from either “Voice”, “Data” or “Fax”, then press  to select.

Note















- “Data” or “Fax” may not be displayed depending on the SIM card.

Settings (M 9)

Phone Settings (M 9-1)

Changing the Language (M 9-1-1)

You can change the language that the phone uses to display messages.

1. Press  to display the Main menu.
2. Press , ,  or  to highlight “Settings”, then press  to select.
3. Press  or  to highlight “Phone Settings”, then press  to select.
4. Press  or  to highlight “Language”, then press  to select.
5. Press  or  to highlight the desired language, then press  to select.

Tip

- You can also change the input language on the text entry screen. (p. 30)

Note

- If you select “Automatic” in step 5, the language preset on the SIM card is selected.

- If the language preset on the SIM card is not supported, then the default language of the phone is selected.

Setting the Main Display (M 9-1-2)















You can change the settings of the Main Display.







Wallpaper for the Main Display

For the stand-by screen of the main display an animation and 3 pictures are provided.

Pictures taken with the digital camera or images downloaded from a WAP site can be used for wallpapers.

To Set Built-in Animation or Pictures of the Main Display

1. Press  to display the Main menu.
2. Press , ,  or  to highlight “Settings”, then press  to select.
3. Press  or  to highlight “Phone Settings”, then press  to select.
4. Press  or  to highlight “Main Display”, then press  to select.
5. Press  or  to highlight “Wallpaper”, then press  to select.

6. Press  or  to highlight “Preset Pictures”, then press  to select.
7. Press  or  to highlight the desired animation or picture, then press  [View].
The selected animation or picture is displayed.
8. Press  to set.
The selected animation or picture is displayed on the stand-by screen.











Note

- Even if an animation is selected, the stand-by screen displays a still picture when you do not operate the phone for about 30 seconds (Differs according to the selected data).

Tip

- To cancel the Wallpaper setting, select “Off” in step 6.

To Set My Pictures for the Main Display

1. Perform steps 1 to 5 in “To Set Built-in Animation or Pictures of the Main Display” on page 136.
2. Press  or  to highlight “My Pictures”, then press  to select.
The file names of the pictures that are registered in the Saved Pictures are displayed.
3. Press  or  to highlight the picture, then press  to select.
The selected picture is displayed.
4. Press  ,  ,  or  to specify the area you wish to display, then press  .
The selected picture is displayed on the stand-by screen.

Note





















- Some pictures cannot be used because of their picture and data types.

Backlight

You can turn the backlight of the main display on or off when you press the keypad or the optional cigarette lighter charger is connected to the phone.

You can change or specify the amount of time the backlight is on for, which will help conserve battery life.

To Turn On/Off the Backlight







1. Press  to display the Main menu.
2. Press , ,  or  to highlight “Settings”, then press  to select.
3. Press  or  to highlight “Phone Settings”, then press  to select.
4. Press  or  to highlight “Main Display”, then press  to select.
5. Press  or  to highlight “Backlight”, then press  to select.
6. Press  or  to highlight “On/Off”, then press  to select.
7. Press  or  to highlight “On” to set backlight on or “Off” to set backlight off, then press  to select.

When you select “On” in step 7:

8. Enter the duration of the backlight using 2 digits, then press .



To Turn On/Off the Backlight whilst Charging with the Cigarette Lighter Charger

With this setting On, the phone’s backlight is on when the cigarette lighter charger is connected. (The backlight of the external display is on, when the phone is closed.)

1. Perform steps 1 to 5 in “To Turn On/Off the Backlight”.
2. Press  or  to highlight “In Car”, then press  to select.
3. Press  or  to highlight “On” to set backlight on or “Off” to set backlight off, then press .

Adjusting the Brightness of the Backlight

You can adjust the brightness of the backlight of the main display from 4 levels.

1. Perform steps 1 to 4 in “To Set Built-in Animation or Pictures of the Main Display” on page 136.
2. Press  or  to highlight “Brightness”, then press  to select.

3. Press ▲ (Light) or ▼ (Dark) to adjust the brightness for maximum clarity.
4. Press ●.

Note

- *The brightness of the backlight above does not affect the brightness of the external display.*

Setting the Display Saving

This phone's screen will automatically turn off after a given amount of time if the phone is left open. This is in order to conserve battery life.

You can change the time before the Display Saving will go into effect from between 2 and 20 minutes.

Tip

- *When you purchase this phone, Display Saving is set to 10 minutes.*
1. Perform steps 1 to 4 in "To Set Built-in Animation or Pictures of the Main Display" on page 136.
 2. Press ▲ or ▼ to highlight "Display Saving", then press ● to select.
 3. Enter the time before Display Saving takes effect in two digits (02 to 20 minutes) using the digit keys, then press ●.

Note

- *Display Saving does not work whilst you are calling, using WAP, or using an application.*

To Cancel the Display Saving Function

The display saving continues until either a key is pressed or there is an incoming alert. The first key press only cancels the Display Saver. You must press another key in order to input any numerical or text value.

Setting the Greeting Message

You can set the message which will appear when the phone is turned on.

1. Perform steps 1 to 4 in "To Set Built-in Animation or Pictures of the Main Display" on page 136.
2. Press ▲ or ▼ to highlight "Greeting Message", then press ● to select.
3. Press ▲ or ▼ to highlight "On", then press ● to select.
4. Enter the message, then press ●.

Up to 16 characters can be stored as a message. For details on entering characters, see "Entering Characters" on page 29.

Tip













- *To cancel the Greeting Message setting, select "Off" in step 3.*

Assigning the Pictures

Pictures can be displayed when turning the power on or off, when receiving an incoming call, or when operating the alarm.

Pictures taken by a digital camera or images downloaded from a WAP site can be used.

















To Set Built-in Pictures

1. Perform steps 1 to 4 in “To Set Built-in Animation or Pictures of the Main Display” on page 136.
2. Press  or  to highlight “Assign Pictures”, then press  to select.
3. Press  or  to highlight the screen to set the picture, then press  to select.
4. Press  or  to highlight “Animation 1” or “Animation 2”, then press  [View].
Or press  or  to highlight “Pattern 1” or “Pattern 2”, then press  [View] when you select “Incoming” or “Alarm” in step 3.
The selected animation or picture is displayed.
5. Press  to set.

Tip

- To cancel the picture setting, select “Default”, then press  in step 4.

To Set My Pictures

1. Perform steps 1 to 4 in “To Set Built-in Animation or Pictures of the Main Display” on page 136.
2. Press  or  to highlight “Assign Pictures”, then press  to select.
3. Press  or  to highlight the screen to set the picture, then press  to select.
4. Press  or  to highlight “My Pictures”, then press  to select.
The file name of the pictures that are registered in the Saved Pictures is displayed.
5. Press  or  to highlight the picture, then press  to select.
The selected picture is displayed.
6. Press , ,  or  to specify the area you wish to display, then press .

Note



















- Some pictures cannot be used because of their picture and data types.

Setting the External Display (M9-1-3)

You can change the settings of the external display.

To Turn On/Off the External Display

You can turn the external display on or off when the phone is closed.























1. Press  to display the Main menu.
2. Press , ,  or  to highlight “Settings”, then press  to select.
3. Press  or  to highlight “Phone Settings”, then press  to select.
4. Press  or  to highlight “External Display”, then press  to select.
5. Press  or  to highlight “LCD On/Off”, then press  to select.
6. Press  or  to highlight “On” to set external display on or “Off” to set external display off, then press  to select.

Wallpaper for the External Display

For the stand-by screen of the external display, an animation and 3 pictures are provided.

Pictures taken with the digital camera or images downloaded from a WAP site can be used for wallpapers.

To Set Built-in Animation or Pictures of the External Display

1. Press  to display the Main menu.
2. Press , ,  or  to highlight “Settings”, then press  to select.
3. Press  or  to highlight “Phone Settings”, then press  to select.
4. Press  or  to highlight “External Display”, then press  to select.
5. Press  or  to highlight “Wallpaper”, then press  to select.
6. Press  or  to highlight “Preset Pictures”, then press  to select.
7. Press  or  to highlight the desired animation or picture, then press  [View].
The selected animation or picture is displayed.
8. Press  to set.
The selected animation or picture is set.



Note

- *Even if an animation is selected, the stand-by screen displays a still picture when you do not operate the phone for about 2 minutes.*
- *When an animation is set as the wallpaper of the external display, the battery consumes large amounts of power and stand-by time may be shortened. To use the battery for a long time, set a still picture for wallpaper for external display or set the wallpaper of the external display setting off.*



Tip

- *To cancel the Wallpaper setting, select “Off” in step 6.*





To Set My Pictures for the External Display

1. Perform steps 1 to 5 in “To Set Built-in Animation or Pictures of the External Display” on page 141.
2. Press  or  to highlight “My Pictures”, then press .

The file names of the pictures that are registered in Saved Pictures are displayed.

3. Press  or  to highlight the picture, then press .

The selected picture is displayed.

4. Press , ,  or  to specify the area you wish to display, then press .

The selected picture is set.

Note

- *Some pictures cannot be used because of their picture and data types.*

To Turn On/Off the Backlight of the External Display

You can turn the backlight of the external display on or off when the phone is closed.

You can also change or specify the duration of the external display backlight.

1. Perform steps 1 to 4 in “To Turn On/Off the External Display” on page 141.
2. Press ▲ or ▼ to highlight “Backlight”, then press ● to select.
3. Press ▲ or ▼ to highlight “On” to set backlight on or “Off” to set backlight off, then press ● to select.

When you select “On” in step 3:







4. Enter the duration of the backlight using 2 digits, then press ●.

To Adjust the LCD Contrast of the External Display
You may sometimes need to adjust the LCD contrast of the external display to suit certain lighting conditions.

1. Perform steps 1 to 4 in “To Turn On/Off the External Display” on page 141.
2. Press ▲ or ▼ to highlight “LCD Contrast”, then press ● to select.
3. Press ▲ (Low) or ▼ (High) to adjust the contrast for maximum clarity.
LCD contrast can be adjusted to 9 levels.
4. Press ●.

To Set Incoming Indication

Illustrations can be displayed on the external display when receiving an incoming call.







1. Perform steps 1 to 4 in “To Turn On/Off the External Display” on page 141.
2. Press  or  to highlight “Incoming Indication”, then press  to select.
3. Press  or  to highlight an illustration from “Illustration 1” to “Illustration 4”, then press  to select.

Tip

- You can preview a selected illustration by pressing  [View].

To Display the Clock on the External Display

You can set the digital/analogue clock to be displayed on the external display.







1. Perform steps 1 to 4 in “To Turn On/Off the External Display” on page 141.
2. Press  or  to highlight “Clock Display”, then press  to select.
3. Press  or  to highlight “Digital Clock 1” to “Digital Clock 3” or “Analogue Clock 1” to “Analogue Clock 3”, then press  to select.

Tip

- You can preview a selected clock by pressing  [View].
- To cancel the clock display, select “Off” in step 3.
- When the wallpaper is set, both the hour and minute hands of the analogue clock are displayed on the wallpaper and the digital image is not displayed.







To Display Icons on the External Display

You can set to display icons on the external display.

1. Perform steps 1 to 4 in “To Turn On/Off the External Display” on page 141.
2. Press  or  to highlight a clock from “Icon Display”, then press  to select.
3. Press  or  to highlight “On” to set icon display on or “Off” to set icon display off, then press  to select.

Phone Setting Reset (M 9-1-4)

The phone settings can be reset to their default settings.

1. Perform steps 1 to 3 in “Changing the Language” on page 136.
2. Press  or  to highlight “Set to Default”, then press  to select.
3. Enter your handset code, then press .
4. Press  [Yes].
To cancel resetting, press  [No] in step 4.

Note

















- *If you enter a wrong handset code in step 3, the operation is cancelled.*

Call Settings (M 9-2)

Set various types of functions and services.

Call Waiting (M 9-2-1)



If you wish to be able to receive another incoming call whilst you have a call in progress, you must activate the Call Waiting service.

1. Press  to display the Main menu.
2. Press , ,  or  to highlight “Settings”, then press  to select.
3. Press  or  to highlight “Call Settings”, then press  to select.
4. Press  or  to highlight “Call Waiting”, then press  to select.
5. Press  or  to highlight “On” to activate the Call Waiting service or “Off” to deactivate it, then press  to select.
6. Press .

Note

- *The Call Waiting service may not be available on all mobile phone networks. Contact your network operator for more information.*







To Check the Call Waiting Service Status

1. Perform steps 1 to 4 in “Call Waiting” on page 145.
2. Press  or  to highlight “Status”, then press  to select.

Now you can check the status of the Call Waiting service.

3. Press  [Back].



Displaying Call Timers (M 9-2-2)



1. Perform steps 1 to 3 in “Call Waiting” on page 145.
2. Press  or  to highlight “Display Call Timers”, then press  to select.
3. Press  or  to highlight “On” or “Off”, then press  to select.

Showing Your Phone Number (M 9-2-3)



This lets you control whether to show your phone number when calling another party or not.

Some networks do not support this service. Please check with your service provider for availability.

1. Perform steps 1 to 3 in “Call Waiting” on page 145.
2. Press  or  to highlight “Show Your Number”, then press  to select.

3. Press  or  to highlight “On” to show your phone number or “Off” not to show your phone number, then press  to select.

To Check the Show Your Number Status







1. Perform steps 1 to 2 in “Showing Your Phone Number”.
2. Press  or  to highlight “Status”, then press  to select.

Now you can check the status of the “Show your Number”.

3. Press .







Adjusting Earpiece Volume (M 9-2-4)

You can adjust the earpiece volume.

1. Perform steps 1 to 3 in “Call Waiting” on page 145.
2. Press  or  to highlight “Earpiece Volume”, then press  to select.
3. Press  to increase the earpiece volume or press  to decrease the earpiece volume, then press .

Picture Call (M 9-2-5)

The image registered to the caller in the Contacts List is displayed when receiving a call.







1. Perform steps 1 to 3 in “Call Waiting” on page 145.
2. Press  or  to highlight “Picture Call”, then press  to select.
3. Press  or  to highlight “On” or “Off”, then press  to select.

Auto Redial (M 9-2-6)

See “Automatic Redialling” on page 22 about this function.







Minute Minder (M 9-2-7)

Minute Minder function informs you of your talk time by sounding a tone after every minute.

1. Perform steps 1 to 3 in “Call Waiting” on page 145.
2. Press  or  to highlight “Minute Minder”, then press  to select.
3. Press  or  to highlight “On” or “Off”, then press  to select.

Call Setting Reset (M 9-2-8)

The call settings can be reset to their default settings.

1. Perform steps 1 to 3 in “Call Waiting” on page 145.
2. Press  or  to highlight “Set to Default”, then press  to select.
3. Enter your handset code, then press .
4. Press  [Yes].
To cancel resetting, press  [No] in step 4.

Note

- If you enter the wrong handset code in step 3, the operation is cancelled and the screen returns to step 3 in “Call Waiting” on page 145.

Diverts (M 9-3)

This service is used to divert incoming calls to your voice mail system or to another number depending on certain conditions in which you cannot answer a call.

Diverting Calls

1. Press to display the Main menu.
2. Press , , or to highlight “Settings”, then press to select.
3. Press or to highlight “Diverts”, then press to select.
4. Press or to highlight one of the divert options, then press to select.

The divert options available are:

- “All Calls”: Diverts all voice calls without ringing.
- “When Busy”: Diverts incoming calls when you are on a call.
- “No Answer”: Diverts incoming calls if you do not answer a call within a certain period of time.
- “Not Reachable”: Diverts incoming calls when your phone is out of network service or switched off.

5. Press or to highlight “On”, then press to select.
6. If you wish to divert calls to a number which is located in the Contacts List, search for the desired Contacts List entry.
Press or to display the Contacts List, and press or to select the desired name, then press . For details on searching the Contacts List entries, see “Finding a Name and Number” on page 40.
7. If you wish to divert calls to a number which you can enter manually, enter the phone number.
8. Press .

If you select “No Answer” in step 4:

9. Press or to highlight the period of time from 6 levels (05 to 30 seconds), then press to select.

Note

- When a divert is set to “All Calls”, “☎” is displayed on the stand-by screen.

Tip

- If you select “By Service” in step 5, you can select further divert options in the selected option in step 4.

Checking the Divert Status

1. Perform steps 1 to 3 in “Diverting Calls” on page 148.
2. Press ▲ or ▼ to highlight the divert option you wish to check, then press ● to select.
3. Press ▲ or ▼ to highlight “Status”, then press ● to select.
You can now check the status of the selected divert option.
4. When you have finished, press ⏪ [Back].

Cancelling All Divert Settings

1. Perform steps 1 to 3 in “Diverting Calls” on page 148.
2. Press ▲ or ▼ to highlight “Cancel All”, then press ● to select.
3. Press ⏩ [Yes].
To cancel resetting, press ⏪ [No] in step 3.

4. Press ●.













All divert settings are cancelled.

To Cancel the Divert Settings Individually

1. Perform steps 1 to 3 in “Diverting Calls” on page 148.
2. Press ▲ or ▼ to highlight the divert option you wish to cancel, then press ● to select.
3. Press ▲ or ▼ to highlight “Off”, then press ● to select.
4. Press ●.
The selected divert has been cancelled.

Date & Time (M 9-4)







You need to set the correct time and date in order for your phone's various time-based functions to work correctly.



1. Press  to display the Main menu.
2. Press , ,  or  to highlight "Settings", then press .
3. Press  or  to highlight "Date & Time", then press .
4. Press  or  to highlight "Set Date/Time", then press .
5. Enter the day, month, year and time using the digit keys, then press .

When you enter the time in the 12-hour format, press  to switch between am and pm.

The order in which the date and time is displayed is based on the format setting. See "To Select the Date Format".









To Select the Time System

1. Perform steps 1 to 3 in "Date & Time".
2. Press  or  to highlight "Clock Settings", then press .
3. Press  or  to highlight "Time Format", then press .











4. Press  or  to highlight "12 hour" or "24 hour", then press .

To Select the Date Format

The date format can be switched between "Day.Month.Year", "Month-Day-Year" or "Year/Month/Day".

1. Perform steps 1 to 3 in "Date & Time".
2. Press  or  to highlight "Clock Settings", then press .
3. Press  or  to highlight "Date Format", then press .
4. Press  or  to highlight "D.M.Y", "M-D-Y" or "Y/M/D", then press .

To Set the Clock Display

1. Perform steps 1 to 3 in "Date & Time".
2. Press  or  to highlight "Clock Settings", then press .
3. Press  or  to highlight "Display Format", then press .
4. Press  or  to highlight "Time Only", "Date Only" or "Date & Time", then press  to select.
To set hide clock, select "Off" in step 4, then press .

Note

- *The above setting is not effective for the clock display setting of the external display.*

To Set Daylight Saving Time

You can switch to daylight saving time without having to change the clock time itself.

1. Perform steps 1 to 3 in “Date & Time” on page 150.
2. Press ▲ or ▼ to highlight “Clock Settings”, then press ● to select.
3. Press ▲ or ▼ to highlight “Daylight Saving”, then press ● to select.
4. Press ▲ or ▼ to highlight “On”, then press ● to select.

To Set the Time Zone

1. Perform steps 1 to 3 in “Date & Time” on page 150.
2. Press ▲ or ▼ to highlight “Set Time Zone”, then press ● to select.
3. Press ▲ or ▼ to highlight “Change Zone”, then press ● to select.
4. Press ◀ or ▶ to set the home city, then press ●.

To Customise the Time Zone















1. Perform steps 1 to 3 in “Date & Time” on page 150.
2. Press ▲ or ▼ to highlight “Set Time Zone”, then press ● to select.
3. Press ▲ or ▼ to highlight “Set Custom Zone”, then press ● to select.
4. Enter the time-zone differences using the digit keys, then press ●.
Each press of  switches – and +.

Network Settings (M 9-5)

Selecting a Network Automatically (M 9-5-1)







Each time the power is turned on, your phone always tries to connect to the preferred network.

If your phone is not connected to the network, you can perform the following immediately to establish the preferred network connection.









1. Press  to display the Main menu.
2. Press , ,  or  to highlight “Settings”, then press  to select.
3. Press  or  to highlight “Network Settings”, then press  to select.
4. Press  or  to highlight “Select Network”, then press  to select.
5. Press  or  to highlight “Automatic”, then press  to select.

To Set the Network Manually

Perform the following if you wish to connect to the networks other than the preferred network which is automatically connected to.

1. Perform steps 1 to 4 in “Selecting a Network Automatically”.
2. Press  or  to highlight “Manual”, then press  to select.
3. Press  or  to highlight the network from the list, then press  to select.

Adding a New Network

1. Perform steps 1 to 4 in “Selecting a Network Automatically”.
2. Press  or  to highlight “Add New Network”, then press  to select.
3. Press  or  to highlight “Add”, then press  to select.
4. Enter the country code.
5. Press .
6. Enter the network code.
7. Press .
8. Enter a new network name.
9. Press .

Editing the Preferred List

To Change the Position of a Network in the Preferred List

1. Perform steps 1 to 4 in “Selecting a Network Automatically” on page 152.
2. Press ▲ or ▼ to highlight “Set Preferred”, then press ● to select.
3. Press ▲ or ▼ to highlight the name of the network to change the position from the list, then press ● to select.
4. Press ▲ or ▼ to highlight “Insert” or “Add to end”, then press ● to select.

To Delete a Network from the Preferred List

1. Perform steps 1 to 3 in “To Change the Position of a Network in the Preferred List”.
2. Press ▲ or ▼ to highlight “Delete”, then press ● to select.

Changing the Network Password (M 9-5-2)

1. Perform steps 1 to 3 “Selecting a Network Automatically” on page 152.
2. Press ▲ or ▼ to highlight “Change Password”, then press ● to select.

3. Enter the old password, then press ●.
4. Enter a new password, then press ●.
5. Enter a new password again, then press ●.
If you enter the incorrect password in step 5, the screen will return to step 2 and you are asked to enter the password again.
6. Press ●.

Selecting an Applicable Zone (M 9-5-3)

Your phone tries to select an applicable zone automatically on startup. You can also select it according to the area.

For America:

1. Perform steps 1 to 3 in “Selecting a Network Automatically” on page 152.
2. Press ▲ or ▼ to highlight “Select Zone”, then press ● to select.
3. Press ▲ or ▼ to highlight “America”, then press ● to select.

For other countries, highlight “Europe, Asia, etc.”, then press ● to select.

Internet Settings (M 9-6)

WAP/MMS Settings

WAP settings and MMS settings can perform following various setups, respectively. In normal operation, you do not need to change these settings.

WAP Settings (M 9-6-1)

Item	Description	Operation
Profile Name*	WAP Profile Name (Unique Name)	Press or to highlight "Profile Name" and press to select. Enter the desired strings and press .
IP Address*	IP address	Press or to highlight "IP Address" and press to select. Enter IP address for WAP and press .
Homepage	Homepage	Press or to highlight "Homepage" and press to select. Enter Homepage URL, if needed, and press .

Item	Description	Operation
Port Number*	Security Option	Press or to highlight "Port Number" and press to select. Enter Port Number (1024-65535) and press .
Circuit Prompt	Circuit Prompt	Press or to highlight "Circuit Prompt" and press to select. Press or to highlight "Enable" or "Disable" and press to select.
Connection Type	Bearer Connection Type	Press or to highlight "Connection Type" and press to select. Press or to highlight "GPRS Then CSD", "GPRS" or "CSD" and press to select.

Item	Description	Operation
GPRS Settings (If "GPRS Then CSD" or "GPRS" is selected as connection type, they should be set)		
APN*	Access Point Name	Press ▲ or ▼ to highlight "APN" and press ● to select. Enter Access Point Name and press ●.
Username	User Name	Press ▲ or ▼ to highlight "Username" and press ● to select. Enter User Name and press ●.
Password	Password	Press ▲ or ▼ to highlight "Password" and press ● to select. Enter Password and press ●.
Linger Time	Linger Time	Press ▲ or ▼ to highlight "Linger Time" and press ● to select. Enter time in seconds (0-99999) and press ●.

Item	Description	Operation
CSD Settings (If "GPRS Then CSD" or "CSD" is selected as connection type, they should be set)		
Phone No.*	Access Point Number	Press ▲ or ▼ to highlight "Phone No." and press ● to select. Enter Access Point Number and press ●.
Line Type	ISDN or Analogue	Press ▲ or ▼ to highlight "Line Type" and press ● to select. Press ▲ or ▼ to highlight "ISDN" or "Analogue" and press ● to select.
Username	User Name	Press ▲ or ▼ to highlight "Username" and press ● to select. Enter User Name and press ●.
Password	Password	Press ▲ or ▼ to highlight "Password" and press ● to select. Enter Password and press ●.

Item	Description	Operation
Linger Time	Linger Time	Press ▲ or ▼ to highlight "Linger Time" and press ● to select. Enter time in seconds (0-99999) and press ●.

*: Item to be set as mandatory.

MMS Settings (M 9-6-2)

Item	Description	Operation
Profile Name*	MMS Profile Name (Unique Name)	Press ▲ or ▼ to highlight "Profile Name" and press ● to select. Enter the desired strings and press ●.
IP Address*	IP address	Press ▲ or ▼ to highlight "IP Address" and press ● to select. Enter IP address for MMS and press ●.
Relay Server URL*	MMS Relay Server	Press ▲ or ▼ to highlight "Relay Server URL" and press ● to select. Enter URL of the Relay Server and press ●.

Item	Description	Operation
Port Number*	Security Option	Press ▲ or ▼ to highlight "Port Number" and press ● to select. Enter Port Number (1024-65535) and press ●.
Connection Type	Bearer Connection Type	Press ▲ or ▼ to highlight "Connection Type" and press ● to select. Press ▲ or ▼ to highlight "GPRS Then CSD", "GPRS" or "CSD" and press ● to select.
GPRS Settings (If "GPRS Then CSD" or "GPRS" is selected as connection type, they should be set)		
APN*	Access Point Name	Press ▲ or ▼ to highlight "APN" and press ● to select. Enter Access Point Name and press ●.

Item	Description	Operation
Username	User Name	Press ▲ or ▼ to highlight "Username" and press ● to select. Enter User Name and press ●.
Password	Password	Press ▲ or ▼ to highlight "Password" and press ● to select. Enter Password and press ●.
Linger Time	Linger Time	Press ▲ or ▼ to highlight "Linger Time" and press ● to select. Enter time in seconds (0-99999) and press ●.
CSD Settings (If "GPRS Then CSD" or "CSD" is selected as connection type, they should be set)		
Phone No.*	Access Point Number	Press ▲ or ▼ to highlight "Phone No." and press ● to select. Enter Access Point Number and press ●.























Item	Description	Operation
Line Type	ISDN or Analogue	Press ▲ or ▼ to highlight "Line Type" and press ● to select. Press ▲ or ▼ to highlight "ISDN" or "Analogue" and press ● to select.
Username	User Name	Press ▲ or ▼ to highlight "Username" and press ● to select. Enter User Name and press ●.
Password	Password	Press ▲ or ▼ to highlight "Password" and press ● to select. Enter Password and press ●.

Item	Description	Operation
Linger Time	Linger Time	Press ▲ or ▼ to highlight "Linger Time" and press ● to select. Enter time in seconds (0-99999) and press ●.



*: Item to be set as mandatory.

To Set Up Your Account Information

This information should be supplied by your Internet service provider.













1. Press  to display the Main menu.
2. Press , ,  or  to highlight “Settings”, then press  to select.
3. Press  or  to highlight “Internet Settings”, then press  to select.
4. Press  or  to highlight “WAP Settings” or “MMS Settings”, then press  to select.
5. Press  or  to highlight the profile name you wish to edit, then press  [Options].
6. Press  or  to highlight “Edit”, then press  or  [Select] to select.
7. Press  or  to highlight the item you wish to edit, then press  to select.
8. Edit each item.
9. When you have finished editing, press  [Save].

To Select Network Connection Profile

1. Perform steps 1 to 4 in “To Set Up Your Account Information”.
2. Press  or  to highlight the profile name to use, then press  to select.

Infrared (M 9-7)

You can use the built-in infrared modem to establish contact between your phone and a PC equipped with an infrared port.

1. Press  to display the Main menu.
2. Press , ,  or  to highlight “Settings”, then press  to select.
3. Press  or  to highlight “Infrared”, then press  to select.
4. Press  or  to highlight “On”, then press  to select.

















“” will appear on the screen.

The infrared setting will return to off when no data is transmitted/received via infrared communication.

Security (M 9-8)

Enabling/Disabling the PIN Code (M 9-8-1)

If the PIN code is enabled you are asked to enter the PIN code each time the phone is switched on. Your PIN code is stored on the SIM card and you should have been made aware of the code when you purchased the SIM card. Contact your service provider for further details.

1. Press  to display the Main menu.
2. Press , ,  or  to highlight “Settings”, then press  to select.
3. Press  or  to highlight “Security”, then press  to select.
4. Press  or  to highlight “PIN Entry”, then press  to select.
5. Press  or  to highlight “On” or “Off”, then press  to select.
6. Enter your PIN code, then press .
7. Press .

Note

- If you enter the wrong PIN code three times in step 6, the SIM card will lock. To remove the lock, contact your service provider/SIM card vendor.

To Change PIN Code

This allows you to change the PIN code stored on the SIM card. Before you change the PIN code, select “On” in step 5 in “Enabling/Disabling the PIN Code” on page 160.

1. Perform steps 1 to 3 in “Enabling/Disabling the PIN Code” on page 160.
2. Press ▲ or ▼ to highlight “PIN Entry”, then press ● to select.
3. Press ▲ or ▼ to highlight “Change PIN”, then press ● to select.
4. Enter the existing PIN code, then press ●.
5. Enter a new PIN code, then press ●.
6. Enter a new PIN code again, then press ●.
If you enter a code different from the code which you entered in step 6, the screen returns to step 5. Enter the correct code again.
7. Press ●.

Handset Lock (M 9-8-2)



The Handset Lock is an additional security feature which prevents unauthorised use of the phone or certain features. The default handset lock code is “0000”.

1. Perform steps 1 to 3 in “Enabling/Disabling the PIN Code” on page 160.
2. Press ▲ or ▼ to highlight “Handset Lock”, then press ● to select.
3. Press ▲ or ▼ to highlight “On” or “Off”, then press ● to select.
4. Enter your handset code, then press ●.
If you enter an incorrect handset code, the screen will clear and you are prompted to enter the code again.

To Change Handset Code







Before you change the handset code, select “On” in step 3 in “Handset Lock”. The default handset code is “0000”.

1. Perform steps 1 to 2 in “Handset Lock”.
2. Press ▲ or ▼ to highlight “Change Code”, then press ● to select.
3. Enter the old handset code, then press ●.

4. Enter a new handset code, then press .
5. Enter the new handset code again, then press .
If you enter a code different from the code which you entered in step 5, the screen returns to step 4. Enter the correct code again.















Changing PIN2 Code (M 9-8-3)

PIN2 code is used to protect certain functions in the phone such as Fixed Dialling No. and call cost limits. The following shows you how to change PIN2 code.

1. Perform steps 1 to 3 in “Enabling/Disabling the PIN Code” on page 160.
2. Press  or  to highlight “Change PIN2”, then press .
3. Enter the existing PIN2 code, then press .
4. Enter a new PIN2 code, then press .
5. Enter the new PIN2 code again, then press .
If you enter a code different from the code which you entered in step 5, the screen returns to step 4. Enter the correct code.
6. Press .



Call Barring (M 9-8-4)

This function lets you place restrictions on incoming and outgoing calls. To activate Call Barring you will need the call barring password, which is available from your service provider.

1. Press  to display the Main menu.
2. Press , ,  or  to highlight “Settings”, then press .
3. Press  or  to highlight “Security”, then press .
4. Press  or  to highlight “Call Barring”, then press .
5. Press  or  to highlight call barring option, then press .



The call barring functions available are:

- “Bar Foreign Calls”: Restricts all outgoing international calls.
- “Only Local & Home”: Restricts all outgoing international calls except to your home country.
- “Bar Incoming Calls”: Restricts all incoming calls.



- “Bar Inc if Abroad”: Restricts all incoming calls when you are outside of the coverage from your registered network operator.
 - “Bar Outgoing Calls”: Restricts all outgoing calls except emergency calls.
6. Press  or  to highlight one of the call barring options, then press  to select.

The call barring options available are:





- “All services”: Restricts all services.
- “Voice Calls”: Restricts all voice calls.
- “Data”: Restricts all data calls.
- “Fax”: Restricts all fax calls.
- “Messages”: Restricts all messages.
- “All except msgs”: Restricts all services except messages.

7. Press  or  to highlight “On”, then press  to select.

If you select “Off”, the selected call barring setting is cancelled.

8. Enter the network password, then press .
To change the network password, see “Changing the Network Password” on page 153.
9. Press .
The selected call barring function is activated.
If you enter a wrong network password, the entered password is cleared. Enter the correct the password.

To Check Call Barring Status

1. Perform steps 1 to 6 in “Call Barring” on page 162.
2. Press  or  to highlight “Status”, then press  to select.
Now you can check the status of the selected call barring option.
3. When you finish the confirmation, press  [Back].

To Cancel All Call Barring Settings

1. Perform steps 1 to 4 in “Call Barring” on page 162.
2. Press ▲ or ▼ to highlight “Cancel All”, then press ● to select.
3. Enter the network password, then press ●.
4. Press ●.

All call barring settings are cancelled.

To Cancel the Call Barring Setting Individually

1. Perform steps 1 to 5 in “Call Barring” on page 162.
2. Press ▲ or ▼ to highlight the call barring option you wish to cancel, then press ● to select.
3. Press ▲ or ▼ to highlight “Off”, then press ● to select.
4. Enter the Barring password, then press ●.

The selected call barring setting is cancelled.

Fixed Dialling No. (M 9-8-5)

When the Fixed Dialling No. is enabled, you can only call predefined numbers.

To Enable Fixed Dialling No.

1. Press ● to display the Main menu.
2. Press ▲, ▼, ◀ or ▶ to highlight “Settings”, then press ● to select.
3. Press ▲ or ▼ to highlight “Security”, then press ● to select.
4. Press ▲ or ▼ to highlight “Fixed Dialling No.”, then press ● to select.
5. Enter a PIN2 code, then press ●.
6. Press ▲ or ▼ to highlight “Settings”, then press ● to select.
7. Press ▲ or ▼ to highlight “On”, then press ● to select.

If you select “Off”, Fixed Dialling No. is disabled.

To Add a New Name

1. Perform steps 1 to 5 in “To Enable Fixed Dialling No.” on page 164.
2. Press ▲ or ▼ to highlight “Edit Dial List”, then press ● to select.
3. Press ⌵ [Options] to display the Options menu.
4. Press ▲ or ▼ to highlight “Add New Contact”, then press ● or ⌵ [Select] to select.
5. Add a name and a phone number.
For details on adding a name and a phone number, see “Creating a New Entry” on page 36.
6. Press ⌵ [Save] to save.









To Search a Registered Name

1. Perform steps 1 to 3 in “To Add a New Name”.
2. Press ▲ or ▼ to highlight “Search”, then press ● to select.
3. Search for the desired name.
For details on searching a name, see “Finding a Name and Number” on page 40.

To Edit a Registered Name

1. Perform steps 1 and 2 in “To Add a New Name”.
2. Press ▲ or ▼ to highlight a name you wish to edit, then press ⌵ [Options] to display the Options menu.
3. Press ▲ or ▼ to highlight “Edit”, then press ● or ⌵ [Select] to select.
4. Edit the selected name.
For details on editing a name, see “Editing Contacts List Entries” on page 41.

To Delete a Registered Name











1. Perform steps 1 and 2 in “To Add a New Name” on page 165.
2. Press  or  to highlight a name you wish to delete, then press  [Options] to display the Options menu.
3. Press  or  to highlight “Delete”, then press  or  [Select] to select.
4. Press  [Yes].

The selected name is deleted.

To cancel deletion, press  [No] in step 4.

Master Reset (M 9-9)

All settings can be reset to their default settings.

1. Press  to display the Main menu.
2. Press , ,  or  to highlight “Settings”, then press  to select.
3. Press  or  to highlight “Master Reset”, then press  to select.
4. Enter your handset code, then press .
5. Press  [Yes].

To cancel resetting, press  [No] in step 5.

All settings are reset.

Note

- If you enter a wrong handset code in step 4, the operation is cancelled.

Connecting GX20 to Your PC

You can use the following functions by connecting the GX20 to your PC using an infrared port or RS232C port*:

- GSM/GPRS modem
 - Handset Manager for GX20
- * Requires an optional data cable XN-1DC10 for RS232C (COM) port connection.

System Requirements

Operating System: Windows[®] 98*, Windows[®] Me, Windows[®] 2000**, Windows[®] XP

- * Windows[®] 98 Second Edition, Windows[®] 98 with Internet Explorer 5.01 or later
- **Service Pack 3

Interface: Infrared port or RS232C port
CD-ROM drive

GSM/GPRS Modem

You can use GX20 as a GSM/GPRS modem to access the Internet from your PC.

For details on software support, refer to the following site:

<http://www.sharp-mobile.com>

Handset Manager

You can transmit picture, sound and video clip, and Contacts List entries between your phone and your PC, and can use Contacts List entries on your PC.

For details on software support, refer to the following site:

<http://www.sharp-mobile.com>

Software Installation

1. Insert the supplied CD-ROM into your CD-ROM drive.
The GX20 CD-ROM screen is displayed.
If the GX20 CD-ROM screen is not displayed, double-click [Launcher.exe] in your CD-ROM.
2. Press the desired button.
The installation starts.
3. Follow the on-screen instructions to complete installation.

Note

Infrared communication

- *Infrared ports need to be aligned with each other.*

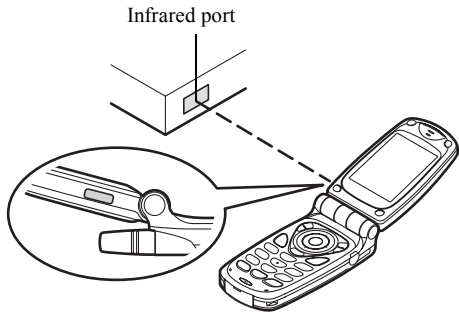

- *Infrared ports need to be placed within 20 cm of each other and within a 30° angle.*
- *It is not recommended that you make or answer a call during data transmission. The operation may be interrupted.*

GSM/GPRS modem

- *It is not recommended that you make or answer calls when you are using GX20 as a GSM/GPRS modem. The operation may be interrupted.*
- *When transmitting data via infrared communication, you need to set the infrared setting to “On”. (p. 160)*

Handset Manager

- *Some large files may not be able to be transmitted from the PC to the phone.*
- *When connecting your phone to a PC, you need to select the connection method for PC Link. (p. 122)*

Troubleshooting

Problem	Solution
The phone does not turn on.	<ul style="list-style-type: none"> • Make sure the battery is properly inserted and charged.
PIN code or PIN2 code is rejected.	<ul style="list-style-type: none"> • Make sure you have entered the correct code (4 to 8 digits). • Your SIM card/protected functions will become locked after 3 unsuccessful attempts. • Contact your SIM provider if you do not have the correct PIN code.
The SIM card becomes locked.	<ul style="list-style-type: none"> • Enter PUK code (8 digits) provided by your service provider (if supported). • If the attempt is successful, enter the new PIN code and confirm your phone is operational again. Otherwise contact your dealer.
The display is difficult to read.	<ul style="list-style-type: none"> • Adjust the backlight brightness for the main display, and adjust the LCD contrast for the external display.

Problem	Solution
Phone functions do not work after the phone is turned on.	<ul style="list-style-type: none"> • Check the radio signal strength indicator as you may be outside the service area. • Check to see if any error message is displayed when you turn your phone on. If so, contact your dealer. • Make sure the SIM card is correctly inserted.
Calls cannot be made or received.	<ul style="list-style-type: none"> • If the message "SIM Card Error" is displayed at start-up, you cannot use your SIM card or the SIM card is damaged. Contact your dealer or network service provider. • Check your call barring, fixed dialling setting, remaining battery and call forwarding settings. • Check if your phone is currently performing data communication using Infrared (IrDA) or a data cable. • Check the remaining balance if you are using a pre-paid SIM card.

Problem	Solution
Call quality is poor.	<ul style="list-style-type: none"> Your current location may not provide good call quality (i.e., in a car or train). Move to a location where radio signal strength is greater.
Cannot access network service.	<ul style="list-style-type: none"> Check where your account has been registered and where the service is available.
Cannot send or receive Text Message.	<ul style="list-style-type: none"> Make sure you are correctly subscribed for the Short Message Service, that the network supports this service, and that the centre number is set up correctly. If not, contact your network service provider.
Cannot connect to Multimedia Message service provider.	<ul style="list-style-type: none"> MMS settings and configuration may be missing or incorrect or the network does not support it. Check your service provider's access point number. Contact your service provider to confirm the correct settings.

Problem	Solution
Limited memory available.	<ul style="list-style-type: none"> Delete any unnecessary data.
Call is terminated unexpectedly.	<ul style="list-style-type: none"> Magnetised objects such as health necklaces placed near the phone may terminate the call. Keep your phone away from such objects.
No entries are displayed in the Contacts List	<ul style="list-style-type: none"> Confirm that the source setting (Handset or SIM) and View Groups setting are made correctly.
Fax transmission failure	<ul style="list-style-type: none"> Before transmitting fax data, configure your fax software to use the software flow control. Use of the optional data cable is recommended for transmitting fax data.

Safety Precautions and Conditions of Use

Your phone conforms to international regulations insofar as it is used under normal conditions and in accordance with the following instructions.

CONDITIONS OF USE

Electromagnetic waves

- Do not switch on your phone aboard an aircraft (as your phone may interfere with the aircraft's electronic systems). Current legislation forbids this use and legal action can be taken against the user.
- Do not switch on your phone in a hospital, except in designated areas.
- Use of your phone's function may affect the performance of medical electronic units (pacemakers, hearing aids, insulin pumps, etc.). When the phone function is on, do not bring it near medical equipment or into areas in which medical equipment is being used. If you have a hearing aid or a pacemaker, only use the phone on the opposite side of your body from where it is located. The phone should be kept at least 6 inches (15.24 cm) from a pacemaker ANYTIME the phone is switched on.

- Do not switch on your phone near gas or flammable substances.
- Observe the rules concerning the use of mobile phones at gasoline stations, chemical plants and at all sites where a risk of explosion exists.

Caring for your phone

- Do not allow children to use your phone without supervision.
- Do not open or attempt to repair your phone yourself. The product can only be repaired by authorised service personnel.
- Do not drop your phone or subject it to severe impacts. Bending the body and pushing the display or keys with extreme force could damage the phone.
- Do not use solvents to clean your phone. Use only a soft, dry cloth.
- Do not carry your phone in your back pocket as it could break when you sit down. The display is made of glass and is particularly fragile.
- Avoid touching the external connector on the underside of the phone, since the delicate components within can be damaged by static electricity.

Battery

- Use your phone only with batteries, chargers and accessories recommended by the manufacturer. The manufacturer disclaims any liability for damage caused by the use of other chargers, batteries or accessories.
- **Network configuration and phone usage will affect talk-time and stand-by time.**
Using the games or camera will hasten battery consumption.
- **When the battery charging alert is displayed on the screen, charge the battery as soon as possible.** If you continue using your phone ignoring the alert, the phone may cease to function, and all data and settings you have stored may be lost at any moment.
- Before removing the battery from the phone, make sure the phone is switched off.
- Replace and charge the new battery as soon as possible after removing the old one.
- Do not touch the battery terminals. Batteries can cause damage, injury or burns if a conductive material touches exposed terminals. When the battery is detached from the phone, use a cover made of non-conductive material for keeping and carrying the battery safely.

- Recommended temperature for using and storing batteries is approximately 20°C.
- The batteries' performance is limited in low temperatures, particularly below 0°C and the phone may not work temporarily regardless of the amount of remaining battery power.
- Exposing the phone to extreme temperatures will shorten battery life.
- The battery can be charged and discharged hundreds of times but it will eventually wear out. When the operating time (talk-time and stand-by time) is noticeably shorter than normal, it is time to buy a new battery.

CAUTION

RISK OF EXPLOSION IF BATTERY IS REPLACED
BY AN INCORRECT TYPE,
DISPOSE OF USED BATTERIES ACCORDING
TO THE INSTRUCTIONS

See "Battery Disposal" on page 14.

Aerial Care

- Do not touch the aerial unnecessarily, whilst using the mobile phone. If it is held, call quality may be hindered leading to shortened talk-time and stand-by time because the mobile phone may have to operate on a higher power level than is necessary.

- Use only the aerial supplied or one approved by Sharp for your mobile phone. Using unauthorised or modified aerials may damage the mobile phone. Moreover, since the mobile phone may violate the appropriate regulations, it may lose performance or exceed the limitation of SAR levels.
- To avoid impaired performance, do not damage the aerial of the mobile phone.
- Whilst talking directly to the microphone, please hold the mobile phone so that the aerial is upwards over your shoulder.
- To avoid interfering with blasting operations, please turn off the mobile phone in a blasting area or in a place where a “turn off two-way radio” sign is posted.

Camera Operation

- Learn picture quality, file formats, etc. beforehand. The display supports up to 65,536 colours. The taken pictures can be saved in JPEG format (JPEG high-colour).
- Be careful not to move your hand whilst taking pictures.

If the phone moves whilst taking a picture, the picture can be blurred. When taking a picture, hold the phone firmly to prevent it from moving, or use the delay timer.

- Clean the lens cover before taking a picture. Fingerprints, oils, etc. on the lens cover hinder clear focusing. Wipe them off with a soft cloth before taking a picture.

Others

- As with any electronic storage unit, data may be lost or corrupted under various circumstances.
- Before connecting the phone with a PC or a peripheral unit, read the operation manual for the other unit carefully.
- If the phone’s battery has been removed for some time, or the phone has been reset, the unit’s clock and calendar may be reinitialised. The date and time should be updated in this case.
- Use only the attached hands free. Some phone’s functions may not work when unauthorised hands free are used.

- The phone uses the magnet to recognise that the phone is closed. Do not place magnetic cards near your phone or get the card caught in the phone as it may damage the recorded data.
- Do not flash the mobile light into eyes as this may damage eyesight or cause dizziness leading to accidents or injury.

ENVIRONMENT

- Keep your phone away from extreme heat. Do not leave it on the dashboard of a car or near a heater. Do not leave it in any place that is extremely damp or dusty.
- Since this product is not waterproof, do not use it or store it where fluids such as water can splash onto it. Raindrops, water spray, juice, coffee, steam, perspiration, etc. will also cause a malfunction.

PRECAUTIONS CONCERNING VEHICLE USE

- It is the user's responsibility to verify if local laws permit the use of a mobile phone in a vehicle. Give full attention to driving. Pull off onto the side of a road and park the car before making or answering a call.
- If local laws permit, we recommend that you use your phone with the attached hands free.
- Use of your phone's function may interfere with the vehicle's electronic systems, such as the ABS anti-lock brakes or the air-bag. To ensure no such problem occurs, please check with your dealer or car manufacturer before connecting your phone.
- Only allow qualified service maintenance personnel to install the vehicle accessories.

The manufacturer disclaims any liability for damage which may result as a consequence of improper use or use contrary to the instructions contained herein.

SAR

Your Sharp mobile phone has been designed, manufactured and tested so as not to exceed the limits for exposure to electromagnetic fields recommended by the Council of the European Union. These limits are part of comprehensive guidelines developed by independent scientific organisations. The guidelines include a substantial safety margin designed to assure the safety of the phone user and others and to take into account variations in age and health, individual sensitivities and environmental conditions. European standards provide for the amount of radio frequency electromagnetic energy absorbed by the body when using a mobile phone to be measured by reference to the Specific Absorption Rate (SAR). The SAR limit for the general public is currently 2 watts per kilogram averaged over 10 grams of body tissue. Your Sharp mobile phone SAR value is 0.586 watts per kilogram. This has been tested to ensure that this limit is not exceeded even when the phone is operating at its highest certified power. In use however your Sharp mobile phone may operate at less than full power because it is designed to use only sufficient power to communicate with the network.

Index

Symbols

key 10

* /Shift key 9

A

Accessories 7

Alarm 116

 Changing alarm settings 118

 Disabling alarm function 118

 Resetting alarm setting 119

 Resetting all alarm settings 119

 Setting alarm 116

 Setting time zone 151

Any Key Answer 129

Applications 83, 114

 Alarm 116

 Backlight 102

 Calculator 119

 Calendar 114

 Checking information 85

 Clearing all applications 105

 Deleting 85

 Downloading 83, 101

 Ending 85

 Executing 84, 100

Java™ information 105

Online confirmation 104

Online setting 100

Operation priority 101

PC Link 122

Phone Help 122

Reset 104

Resume time 101

Setting blinking operation 103

SIM Application Tool 114

Suspending 85

Vibration 103

Voice memo 121

Volume 102

Area Info 78

 Enabling/Disabling 78

B

Battery 11

 Charging 14

 Disposal 14

 Inserting 11

 Removing 13

Battery level indicator 15

Bookmarks 97

Busy tone 23

C

Calculator 119

 Rate conversion 120

Calendar 114

 Deleting schedules 115

 Finding a particular date 114

Call 21

 Answering 23

 Ending 22

 Holding 24

 Making 21

 Making another call during a
 call 24

 Putting on hold 24

 Rejecting 23

Call Costs 132

 Checking charge limit 134

 Checking charge rate 133

 Checking cost of last call 132

 Checking residual credit 134

 Checking total call cost 133

 Resetting all call costs 134

 Setting charge limit 133

 Setting charge rate 133

Call Log 130

- Deleting 131
 - Sending messages 130
 - Viewing 130
 - Call Settings 145
 - Adjusting earpiece volume 146
 - Auto Redial 147
 - Call waiting 145
 - Display Call Timers 146
 - Minute Minder 147
 - Resetting 147
 - Show Your No. 146
 - Call Timers 131
 - Checking duration of last call 131
 - Checking total call time 131
 - Resetting all call timers 132
 - Call waiting 25, 145
 - Camera 10, 47
 - Digital camera 47
 - Video camera 54
 - Cell Broadcasts 76
 - Enabling/Disabling 76
 - Reading 77
 - Setting languages 77
 - Subscribing 77
 - Centre key 9
 - Centre key/Navigation keys 17
 - Characters 29
 - Changing input method 30
 - Changing the input languages 30
 - Copying text 31
 - Cuttings text 31
 - Entering 29
 - Pasting text 31
 - Symbols and punctuation 30
 - T9 text input 30
 - Table of characters 29
 - Conference call 26
 - Adding new participants 27
 - Ending call with a participant 27
 - Making a conference call 26
 - Private conversation 27
 - Contacts 130
 - Dialling 40
 - Swapping location number of the phone number 46
 - Contacts List 35
 - Adding number from call Log 38
 - Changing the memory to be used 35
 - Creating 36
 - Deleting 42
 - Dialling 40
 - Editing 41
 - Finding 40
 - Memory status 44
 - Sending messages 45
 - Storing input number 38
 - Viewing groups 42
- D**
- Data Counter 134
 - Resetting 134
 - Delivery report
 - Confirming 67
 - Dial tone
 - Muting 28
 - Digital camera 47
 - Adjusting the brightness of the picture 50
 - Continuous shooting 51
 - Deleting pictures 53
 - Indicators 49
 - Retaking pictures 49
 - Selecting light colour 53
 - Selecting the frame 52
 - Selecting the picture quality 48
 - Selecting the picture size 48
 - Selecting the shutter sound 53
 - Sending messages 91
 - Sending pictures 53

- Switching the viewfinder 48
- Taking close-up pictures 48
- Using the timer 51
- Using the zoom function 48
- Viewing the taken pictures 50
- Display indicators 17, 19
 - External display 19
- Diverts 148
 - Cancelling all divert settings 149
 - Cancelling divert settings individually 149
 - Checking divert status 149
 - Divert calls 148
- DTMF tone 28
 - Muting 28
- E**
- Earpiece 9
- Earpiece volume 24
 - Adjusting 24
- Emergency calls 21
- End/Power key 10
- External connector 10
- F**
- Flash light 10
- Fun & Games 100

- G**
- Group call 43
- H**
- Hands free connector 9
- I**
- Indicators
 - External display 19
- Infrared 160
- Infrared port 10
- Input languages
 - Changing 30
- Input method 30
 - Changing 30
- International calls 21
- L**
- Left soft key 9, 17
- M**
- Macro dial 10
- Main display 9, 17
- Main menu 32
 - List of menu functions 34
 - Operation guidance 32
 - Shortcut keys 32
- Master reset 166
- Melody Editor 105

- Copying/Pasting notes 113
- Creating your original ringtone 105
- Deleting 111
- Editing 112
- Musical scale/rest 107
- Strength 111
- Tone 109
- Types of notes/rests 108
- Memory status 99
- Menu 32
 - Main menu 32
 - Operation guidance 32
 - Shortcut keys 32
- Messages
 - MMS 59
 - SMS 70
- Microphone 10
 - Muting 28
- Mobile light 10, 14
- Multimedia Message 59
 - Adding recipients 61
 - Check the sender and receiver phone number or e-mail address 64
 - Creating 59
 - Deleting 68

- Forwarding 65
- Inserting attached data 62
- Lock/Unlock 68
- Making a call 68
- Modifying 66
- Reading 64
- Replying 65
- Re-sending 67
- Retrieving 66
- Saving in Drafts box 61
- Sending message in Drafts box 63
- Setting up 69
- Storing the phone number or e-mail address of a sender in the Contacts List 66
- Turning the slide show setting on or off 62
- My Numbers 135
- My Stuff 83

N

- Navigation keys (Arrow keys) 9, 32
- Network settings 152
 - Adding new network 152
 - Changing network password 153
 - Editing preferred list 153

- Selecting a network automatically 152

P

- PC connection
 - GSM/GPRS modem 167
 - Handset Manager 167
 - Software installation 167
 - System requirements 167
- Phone settings 136
 - Assigning pictures 140
 - Backlight 138
 - Brightness of backlight 138
 - Changing language 136
 - Display saving 139
 - External display 141
 - Greeting message 139
 - Main display 136
 - Resetting 145
- Pictures 86
 - Adjusting size 90
 - Changing file name 89
 - Checking information 92
 - Deleting 91
 - Downloading 89
 - Editing pictures 87
 - Saving to Contacts List 86
 - Sending messages 91

- Using as wallpaper 86
- Viewing 89

- PIN code 160
- PIN2 code 162

Profiles 123

- Activating 123
- Customising 124
- Keypad tones 126
- Low battery alert 129
- Melody assignment 125
- Message alert 128
- Power on/off sound 128
- Resetting 124
- Ringer volume 125
- Vibration 126
- Warning tone 127

R

- Redialling 22
 - Auto redial 22
- Right soft key 9, 17
- Ringtones 43

S

- SAR 175
- Screensavers 100
- Security 160
 - Call Barring 162

- Changing handset code 161
- Changing PIN code 161
- Changing PIN2 code 162
- Enabling/Disabling PIN code 160
- Fixed Dialling No. 164
- Handset Lock 161
- Send key 9
- Settings 136
 - Any Key Answer 129
 - Call settings 145
 - Date & Time 150
 - Diverts 148
 - Infrared 160
 - Internet 154
 - Master Reset 166
 - MMS 156
 - Network settings 152
 - Phone settings 136
 - Security 160
 - WAP 154
- SIM card 11
 - Inserting 11
 - Removing 13
- Sounds 92
 - Changing file name 93
 - Checking information 93

- Deleting 94
- Downloading 92
- Playing back 93
- Sending messages 94
- Strength 94
- Tone 94
- Speaker 10
- Speed Dial List 135
 - Assign 135
 - Clear All 135
 - Delete 135
 - Re-assign 135
- Speed dialling 21, 45
- Status indicators 17

T

- Text (SMS) 70
- Text message 70
 - Calling 73
 - Connection type 76
 - Creating 70
 - Deleting 74
 - Extracting phone numbers 74
 - Forwarding 73
 - Message format 75
 - Modifying 73
 - Optimisation 76
 - Reading 72

- Replying 72
- Saving in Outbox 70
- Sending 71
- Setting up 75
- Validity period 75
- Text template 98
 - Adding phrases 98
 - Deleting 99
 - Editing 98
 - Using 31, 61, 70
 - Viewing 98
- Troubleshooting 169
- Turning your phone on and off 16

V

- Video camera 54
 - Adjusting the brightness of the video clips 56
 - Deleting video clips 58
 - Indicators 55
 - Recording close-up video clips 54
 - Recording video clips 54
 - Recording video clips with sound 58
 - Selecting light colour 58
 - Selecting the video quality 55
 - Sending video clips 58

- Using the timer 57
- Using the zoom function 55
- Viewing the recorded video clips 56
- Video clips 95
 - Changing file name 96
 - Checking information 96
 - Deleting files 97
 - Downloading 95
 - Playing back 95
 - Sending messages 96
- Viewfinder switch key 9
- Vodafone live! 79
 - Adding a bookmark 81
 - Browser menu 80
 - Exiting WAP browser 79
 - Navigating WAP page 80
 - Viewing WAP browser 79
- Voice mail key 9
- Voice memo 121
 - Playing back 121
 - Recording 121

W

- WAP settings 154